

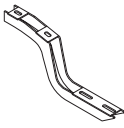









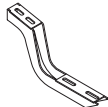

# BRACKET KIT INSTALLATION

SKU# RB-0402-BK

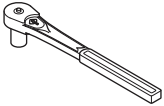
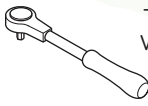

COMPONENTS		HARDWARE	
<b>DRIVER SIDE</b>  Qty: 1 Front Bracket  Qty: 1 Center Bracket  Qty: 1 Rear Bracket	<b>PASSENGER SIDE</b>  Qty: 1 Front Bracket  Qty: 1 Center Bracket  Qty: 1 Rear Bracket	 Qty: 12 M8 x 30MM Hex Head Bolts  Qty: 24 M8 Flat Washers  Qty: 12 M8 Hex Head Nuts	 Qty: 24 M8 Lock Washers
TOOLS REQUIRED		INSTALLATION NOTES	
 METRIC/STANDARD RATCHET  TORQUE WRENCH  13MM SOCKET  13MM WRENCH		TORQUE NOTE: Bolts and nuts should be torqued to 15-20 ft lbs. NOTE: Hardware for Board Installation is included. NOTE: Some spare hardware is included.	

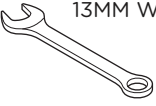
Remove all contents from the package and check brackets for any damage. Also, verify that all components and hardware listed above are included before you begin installation. If anything is missing or damaged please contact us at [customerservice@raptorseries.com](mailto:customerservice@raptorseries.com)

Read through entire installation manual and installation drawings to ensure that you understand all of the components and hardware before proceeding with installation.

**NOTE: When installing the brackets, all hardware must be left loose until all of the items are attached.**

Locate factory hole locations in three (3) places per side on the body mount.

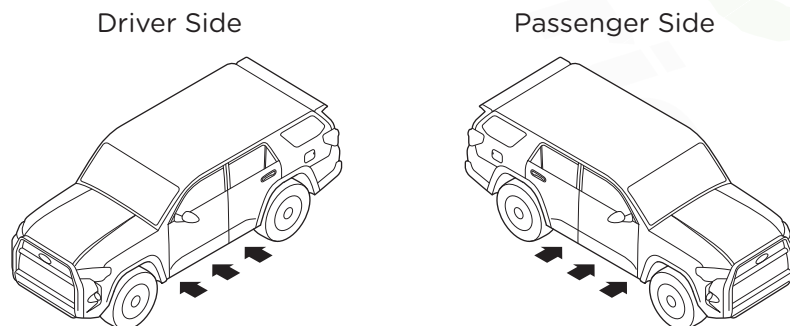

# BRACKET ORIENTATION

DRIVER SIDE

*Raptor*  
Series

1. Begin installation on driver side. Position the Front Bracket, the Center Brackets and the Rear Bracket as shown in diagram.

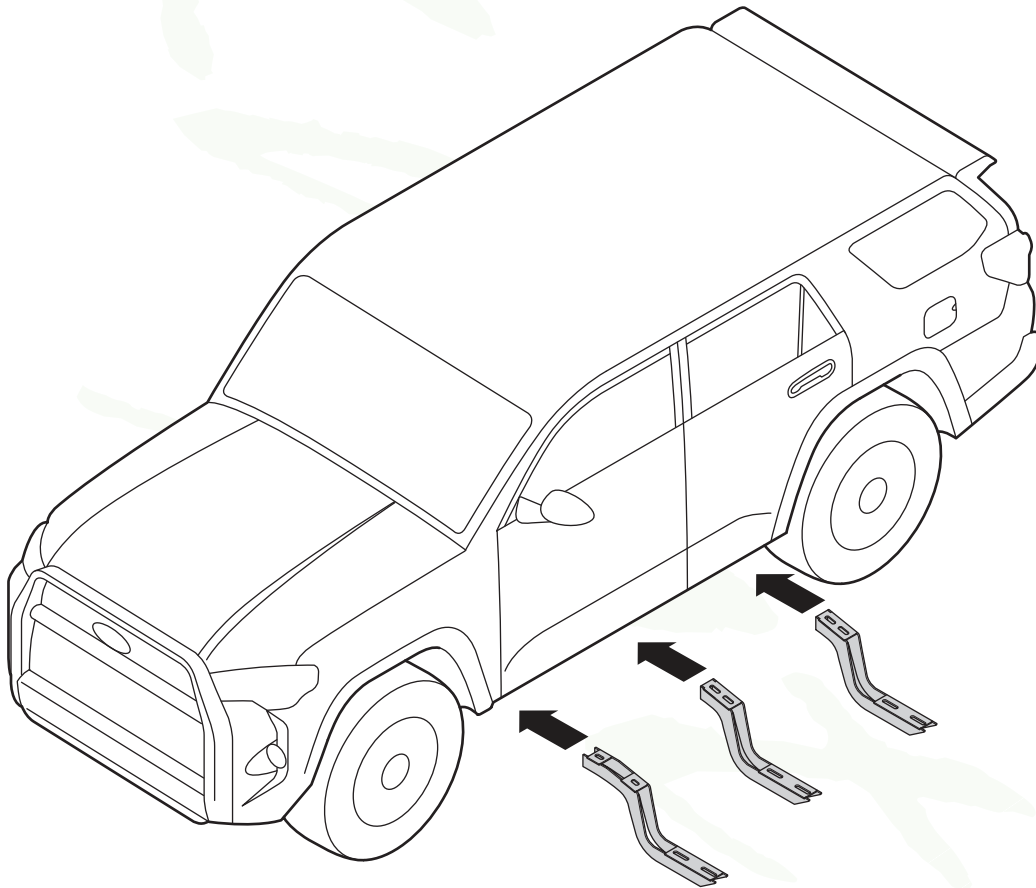

# BRACKET INSTALLATION

## DRIVER SIDE

*Raptor*  
Series

- 2.** Fasten the top portion of the Driver Side Front Bracket by using (2) M8 x 30MM Hex Head Bolts, (2) M8 Flat Washers and (2) M8 Lock Washers.

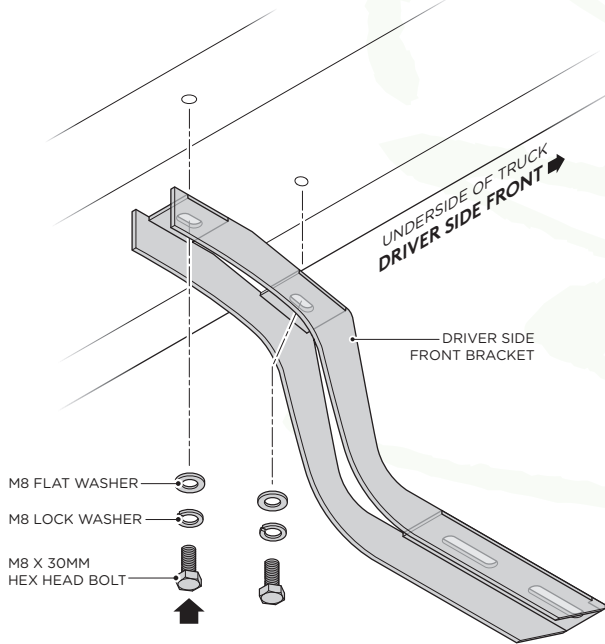

- 3.** Fasten the top portion of the Driver Side Center Bracket by using (2) M8 x 30MM Hex Head Bolts, (2) M8 Flat Washers and (2) M8 Lock Washers.

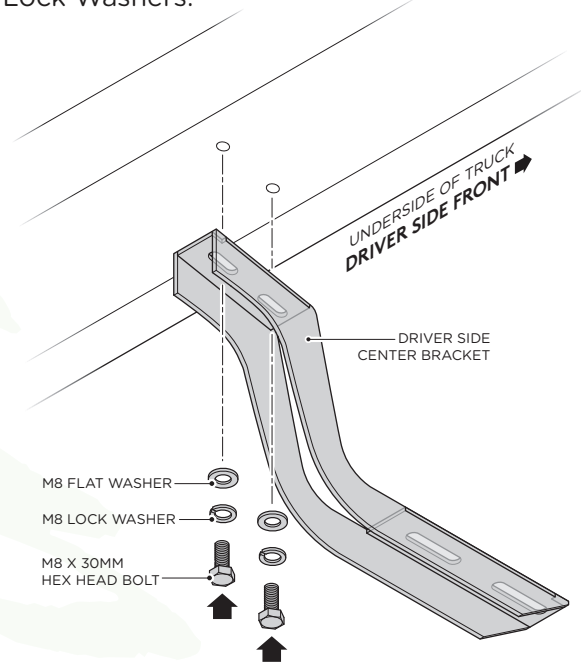

- 4.** Fasten the top portion of the Driver Side Rear Bracket by using (2) M8 x 30MM Hex Head Bolts, (2) M8 Flat Washers and (2) M8 Lock Washers.

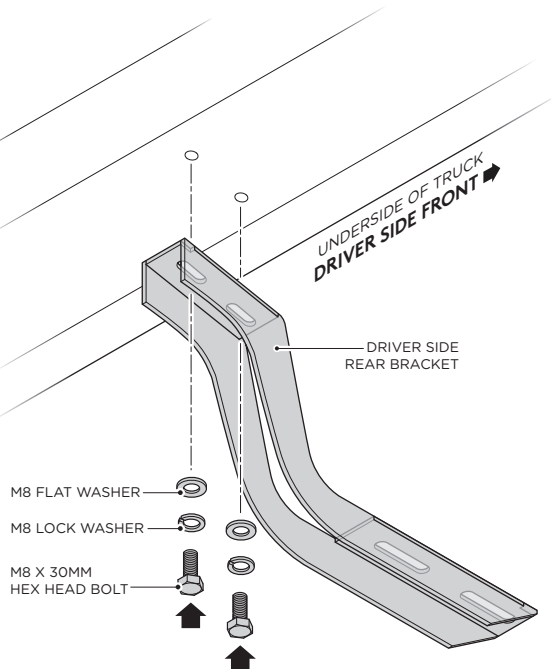

# RUNNING BOARD INSTALLATION

## DRIVER SIDE

*Raptor*  
Series

5. Fasten the Running Board to the Driver Side Front Bracket cradle by using (2) M8 Flat Washers, (2) M8 Lock Washers and (2) M8 Hex Head Nuts.

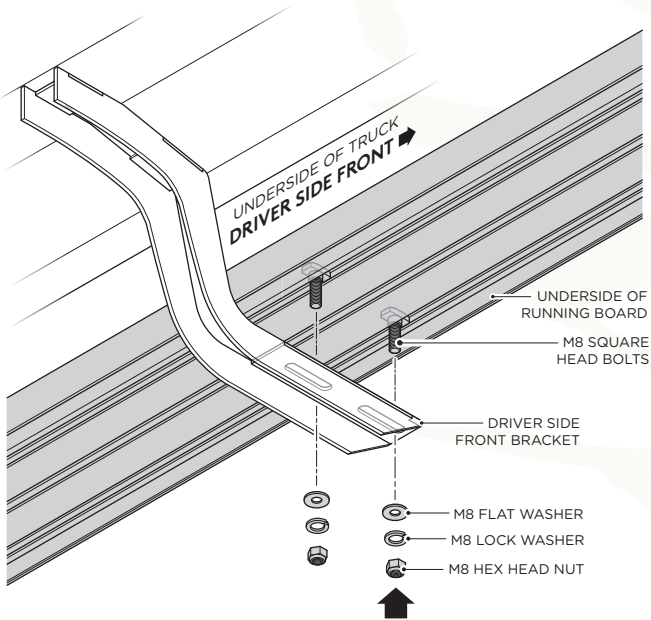

6. Fasten the Running Board to the first Driver Side Center Bracket cradle by using (2) M8 Flat Washers, (2) M8 Lock Washers and (2) M8 Hex Head Nuts.

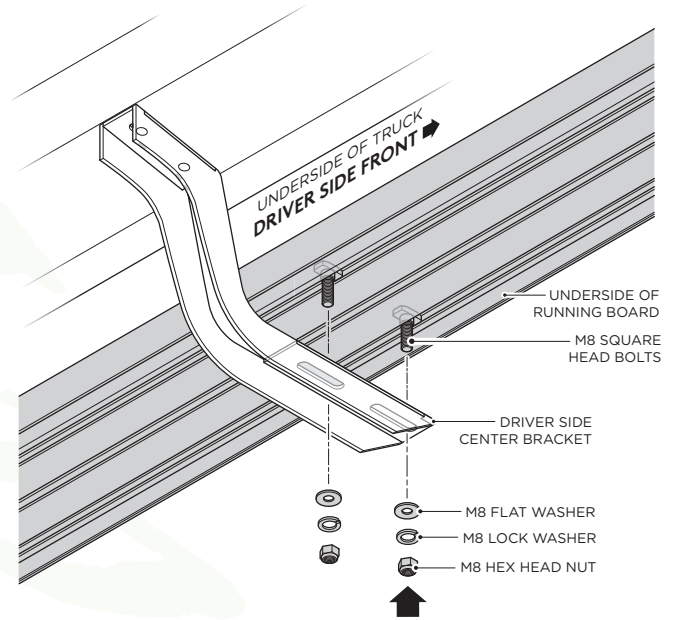

7. Fasten the Running Board to the Driver Side Rear Bracket cradle by using (2) M8 Flat Washers, (2) M8 Lock Washers and (2) M8 Hex Head Nuts.

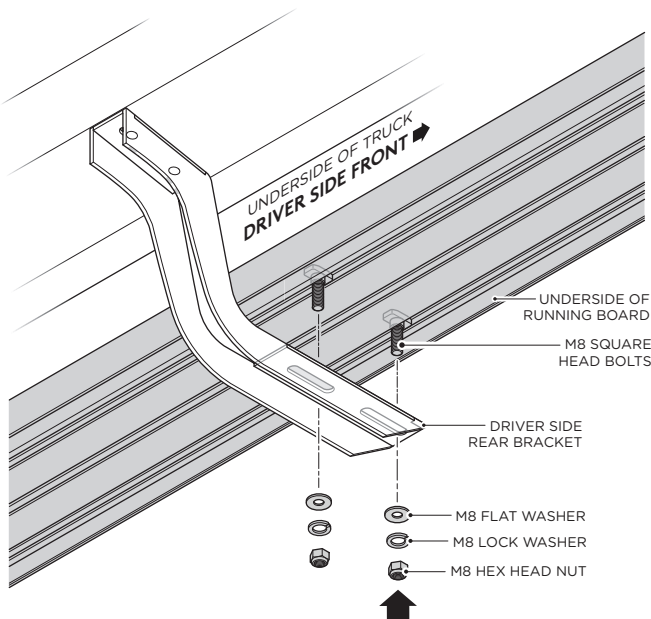

## BRACKET ORIENTATION

### PASSENGER SIDE

*Raptor*  
Series

1. Begin installation on passenger side. Position the Front Bracket, the Center Brackets and the Rear Bracket as shown in diagram.

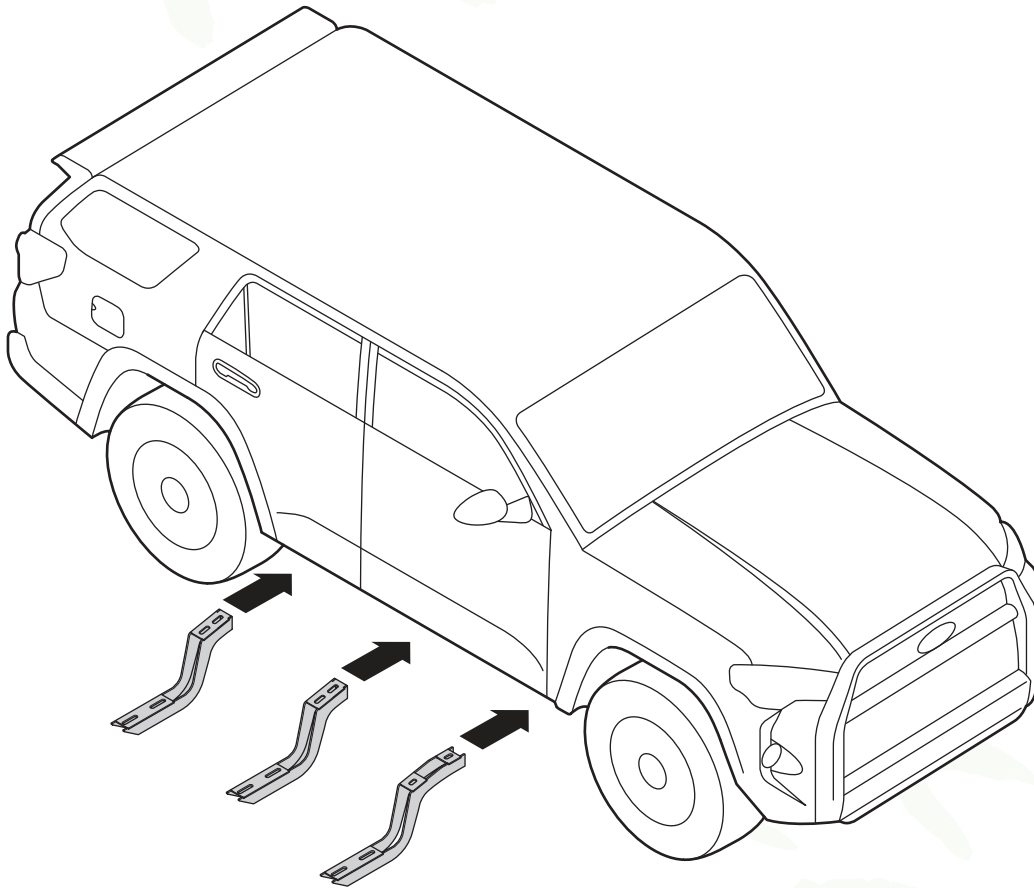

# BRACKET INSTALLATION

## PASSENGER SIDE

*Raptor*  
Series

2. Fasten the top portion of the Passenger Side Front Bracket by using (2) M8 x 30MM Hex Head Bolts, (2) M8 Flat Washers and (2) M8 Lock Washers.

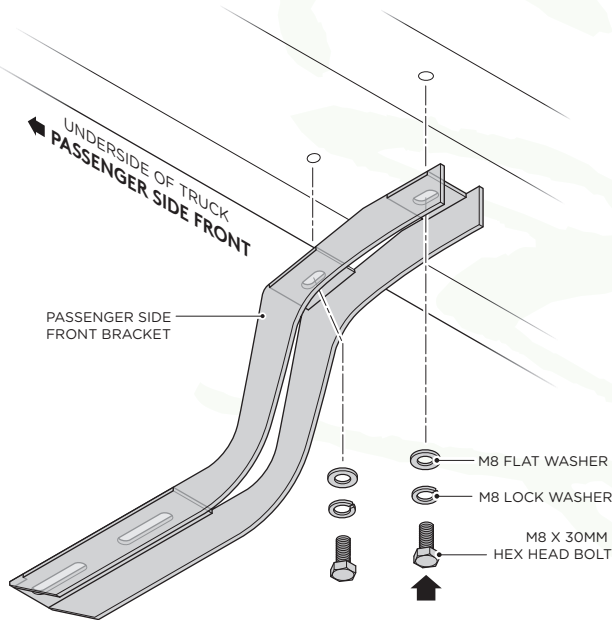

3. Fasten the top portion of the Passenger Side Center Bracket by using (2) M8 x 30MM Hex Head Bolts, (2) M8 Flat Washers and (2) M8 Lock Washers.

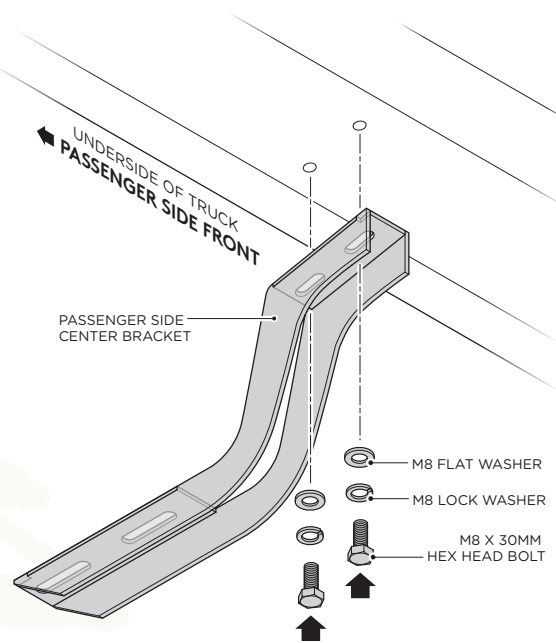

4. Fasten the top portion of the Passenger Side Rear Bracket by using (2) M8 x 30MM Hex Head Bolts, (2) M8 Flat Washers and (2) M8 Lock Washers.

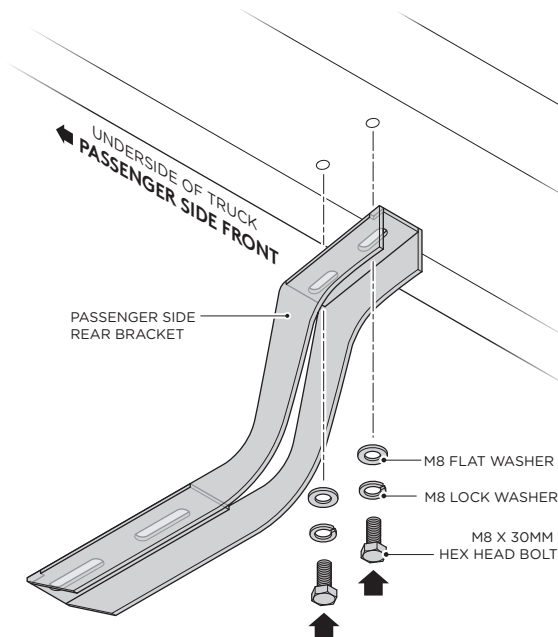

# RUNNING BOARD INSTALLATION

## PASSENGER SIDE



5. Fasten the Running Board to the Passenger Side Front Bracket cradle by using (2) M8 Flat Washers, (2) M8 Lock Washers and (2) M8 Hex Head Nuts.

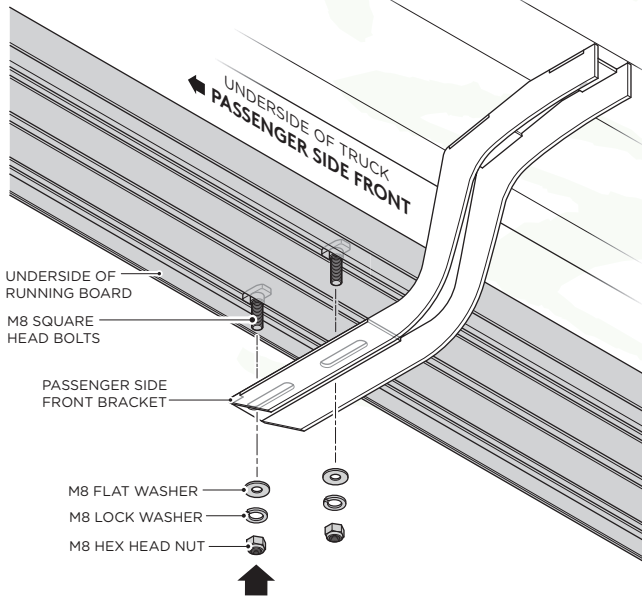

6. Fasten the Running Board to the Passenger Side Center Bracket cradle by using (2) M8 Flat Washers, (2) M8 Lock Washers and (2) M8 Hex Head Nuts.

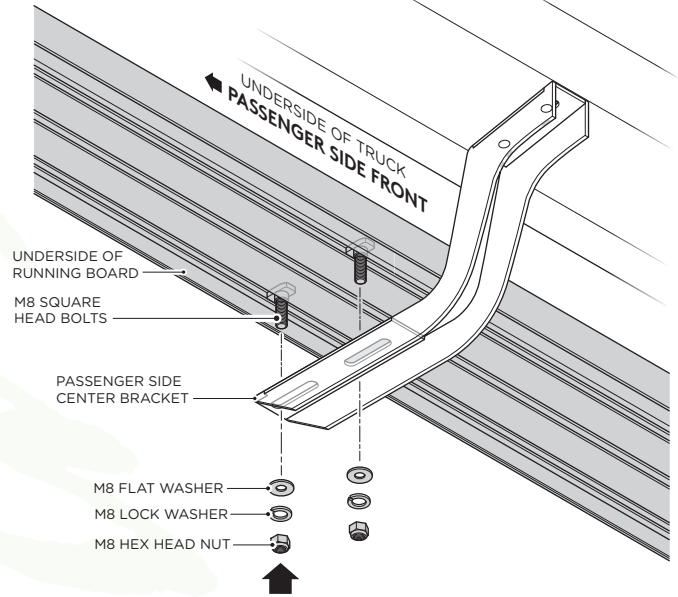

7. Fasten the Running Board to the Passenger Side Rear Bracket cradle by using (2) M8 Flat Washers, (2) M8 Lock Washers and (2) M8 Hex Head Nuts.

