

BRACKET KIT INSTALLATION

SKU# RB-0401-BK



COMPONENTS		HARDWARE	
<p>DRIVER SIDE</p> <p>Qty: 1 Front Bracket</p> <p>Qty: 2 Center Bracket</p> <p>Qty: 1 Rear Bracket</p>	<p>PASSENGER SIDE</p> <p>Qty: 1 Front Bracket</p> <p>Qty: 2 Center Bracket</p> <p>Qty: 1 Rear Bracket</p>	<p>Qty: 18 M8 x 30MM Hex Head Bolts</p> <p>Qty: 34 M8 Flat Washers</p> <p>Qty: 4 M8 Square Head Bolts</p>	<p>Qty: 34 M8 Lock Washers</p> <p>Qty: 18 M8 Hex Head Nuts</p>
TOOLS REQUIRED		INSTALLATION NOTES	
<p>RATCHET</p> <p>TORQUE WRENCH</p> <p>13MM SOCKET</p>	<p>TORQUE NOTE: Bolts and nuts should be torqued to 15-20 ft lbs.</p> <p>NOTE: Hardware for Board Installation is included.</p> <p>NOTE: Some spare hardware is included.</p>		

Remove all contents from the package and check brackets for any damage. Also, verify that all components and hardware listed above are included before you begin installation. If anything is missing or damaged please contact us at customerservice@raptorseries.com

Read through entire installation manual and installation drawings to ensure that you understand all of the components and hardware before proceeding with installation.

NOTE: When installing the brackets, all hardware must be left loose until all of the items are attached.

Locate factory hole locations in two (4) places per side on the body mount.

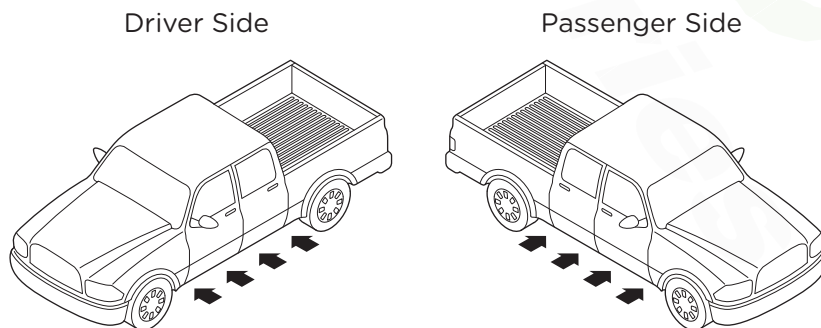

BRACKET ORIENTATION

DRIVER SIDE

Raptor
Series

1. Begin installation on driver side. Position the Front Bracket, the Center Brackets and the Rear Bracket as shown in diagram.

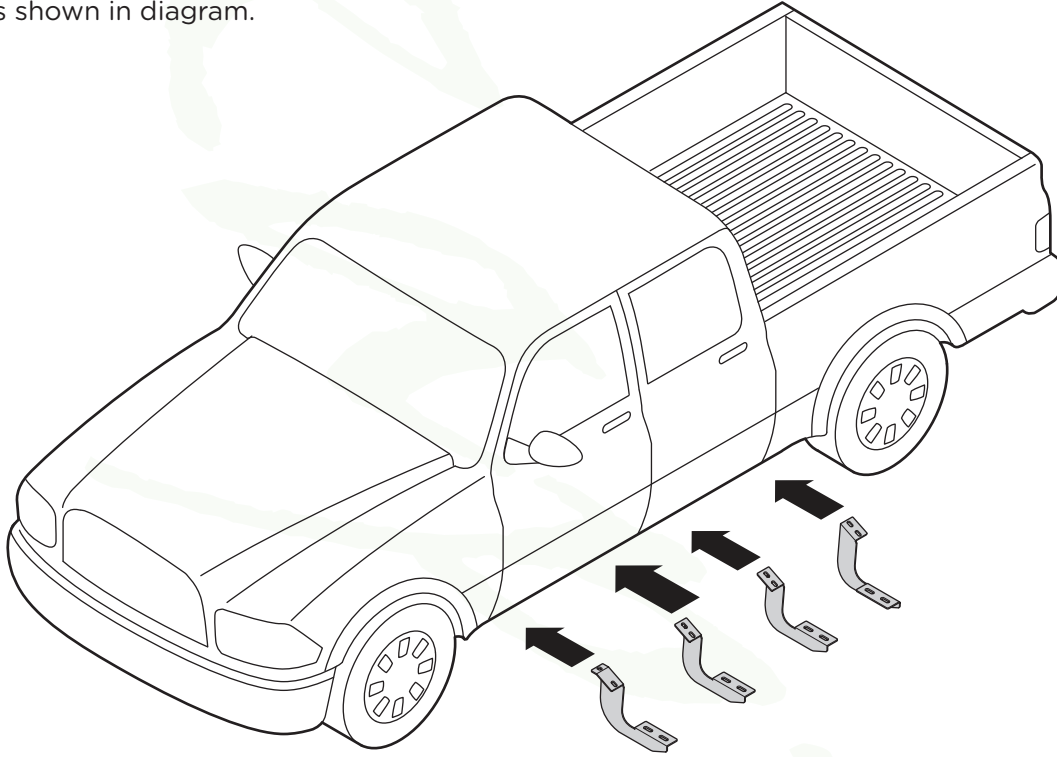

2. Driver Side Front Bracket cradle (2a) and Driver Side Center Bracket cradles (2b, 2c) will face toward the rear of the truck and the Driver Side Rear Bracket cradle (2d) will face toward the front of the truck.

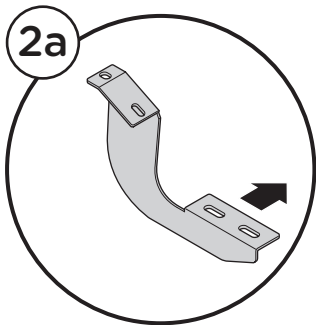

Driver Side
Front Bracket

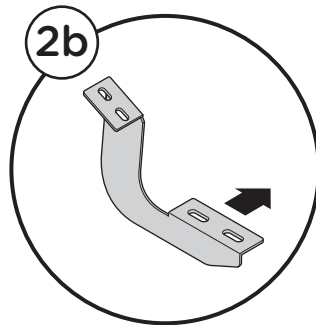

Driver Side
Center Bracket

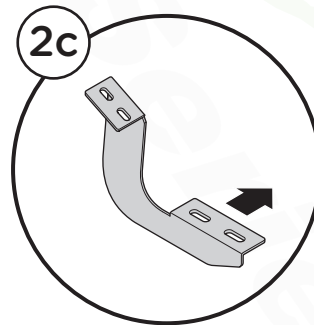

Driver Side
Center Bracket

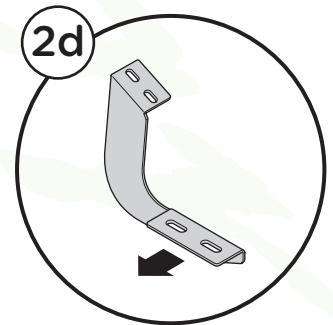

Driver Side
Rear Bracket

BRACKET INSTALLATION

DRIVER SIDE

Raptor
Series

4. Fasten the top portion of the Driver Side Front Bracket by using (2) M8 x 30MM Hex Head Bolts, (2) M8 Flat Washers and (2) M8 Lock Washers.

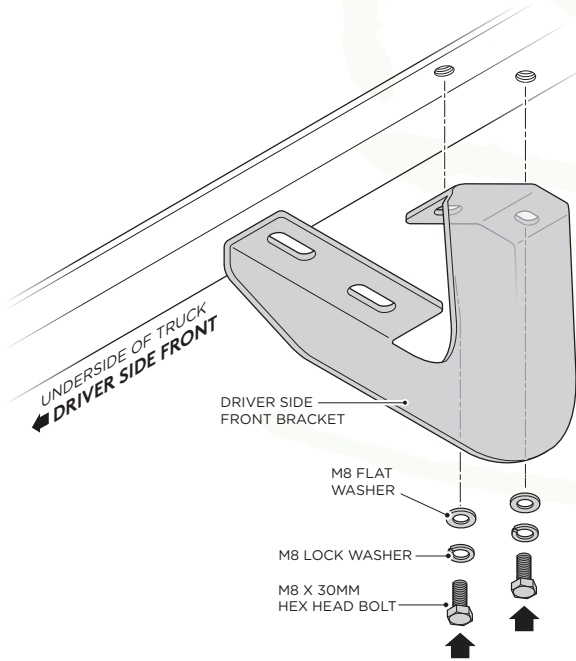

5. Fasten the top portion of the first Driver Side Center Bracket by using (2) M8 x 30MM Hex Head Bolts, (2) M8 Flat Washers and (2) M8 Lock Washers.

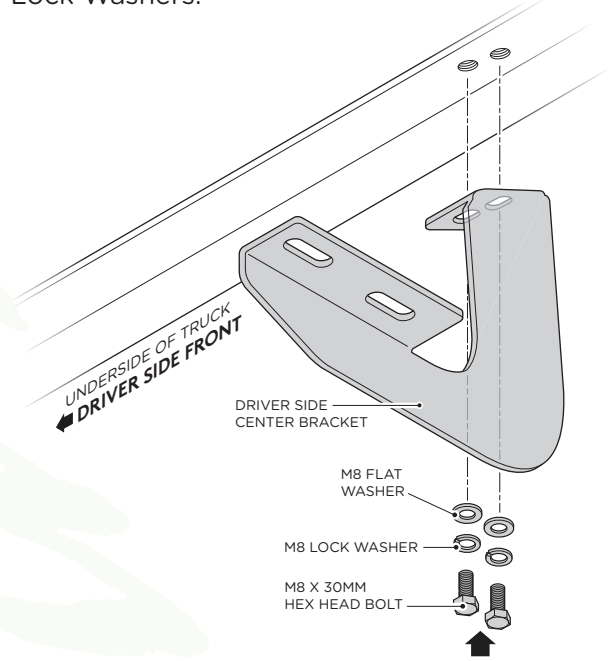

6. Fasten the top portion of the second Driver Side Center Bracket by using (2) M8 x 30MM Hex Head Bolts, (2) M8 Flat Washers and (2) M8 Lock Washers.

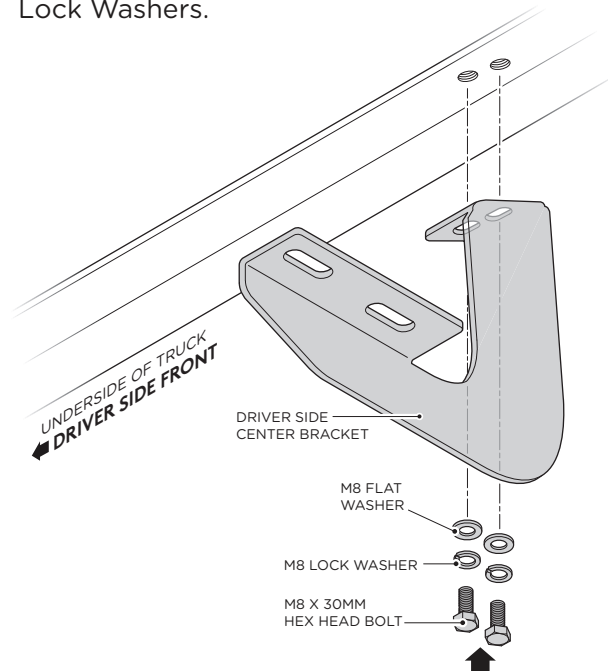

7. Fasten the top portion of the Driver Side Rear Bracket by using (2) M8 x 30MM Hex Head Bolts, (2) M8 Flat Washers and (2) M8 Lock Washers.

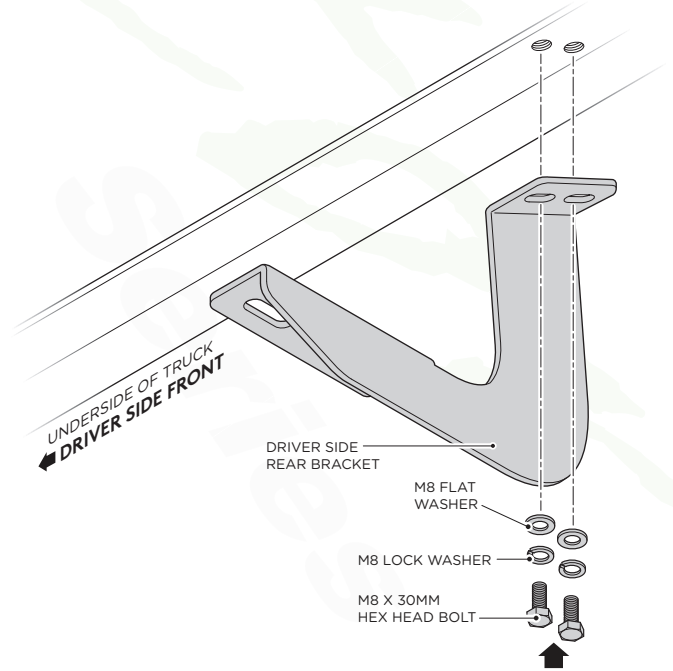

RUNNING BOARD INSTALLATION

DRIVER SIDE

Raptor
Series

- 8.** Fasten the Running Board to the Driver Side Front Bracket cradle by using (2) M8 Flat Washers, (2) M8 Lock Washers and (2) M8 Hex Head Nuts.

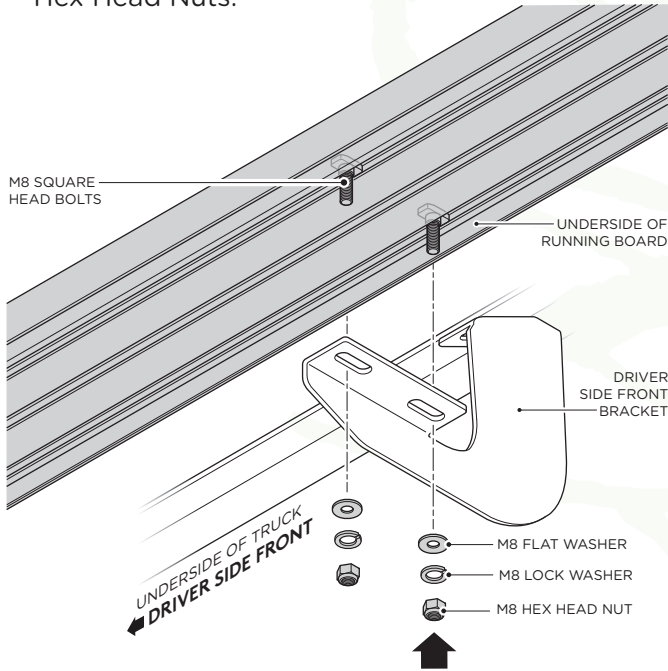

- 9.** Fasten the Running Board to the first Driver Side Center Bracket cradle by using (2) M8 Flat Washers, (2) M8 Lock Washers and (2) M8 Hex Head Nuts.

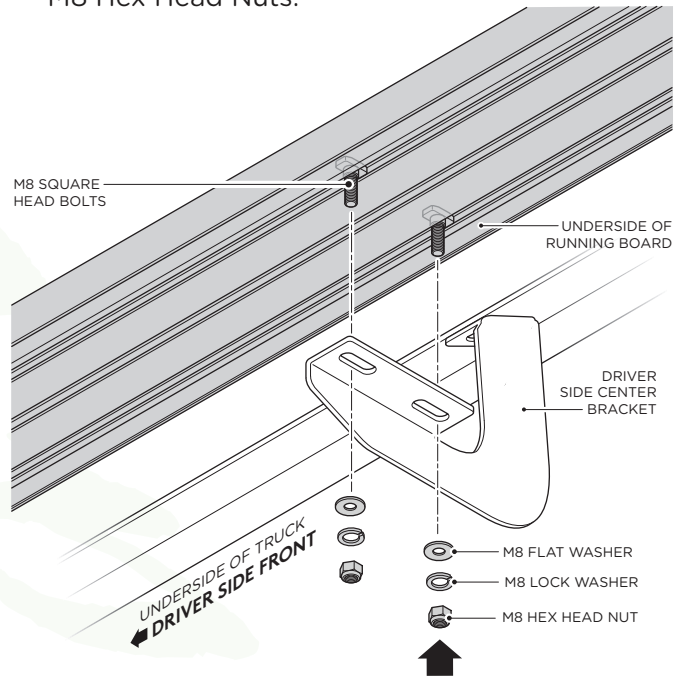

- 10.** To fasten the Running Board to the second Driver Side Center Bracket cradle, insert (2) M8 Square Head Bolts (10a), then fasten using (2) M8 Flat Washers, (2) M8 Lock Washers

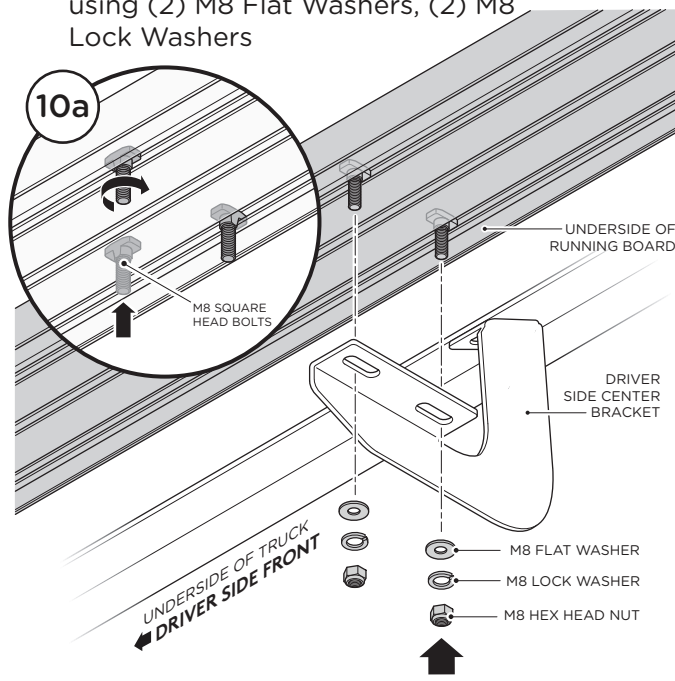

- 11.** Fasten the Running Board to the Driver Side Rear Bracket cradle by using (2) M8 Flat Washers, (2) M8 Lock Washers and (2) M8 Hex Head Nuts.

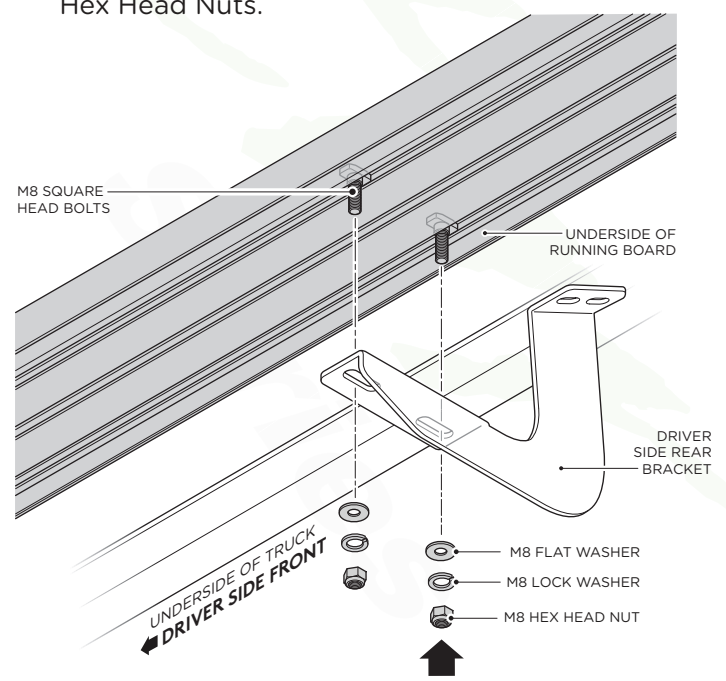

BRACKET ORIENTATION

PASSENGER SIDE

Raptor
Series

1. Begin installation on passenger side. Position the Front Bracket, the Center Brackets and the Rear Bracket as shown in diagram.

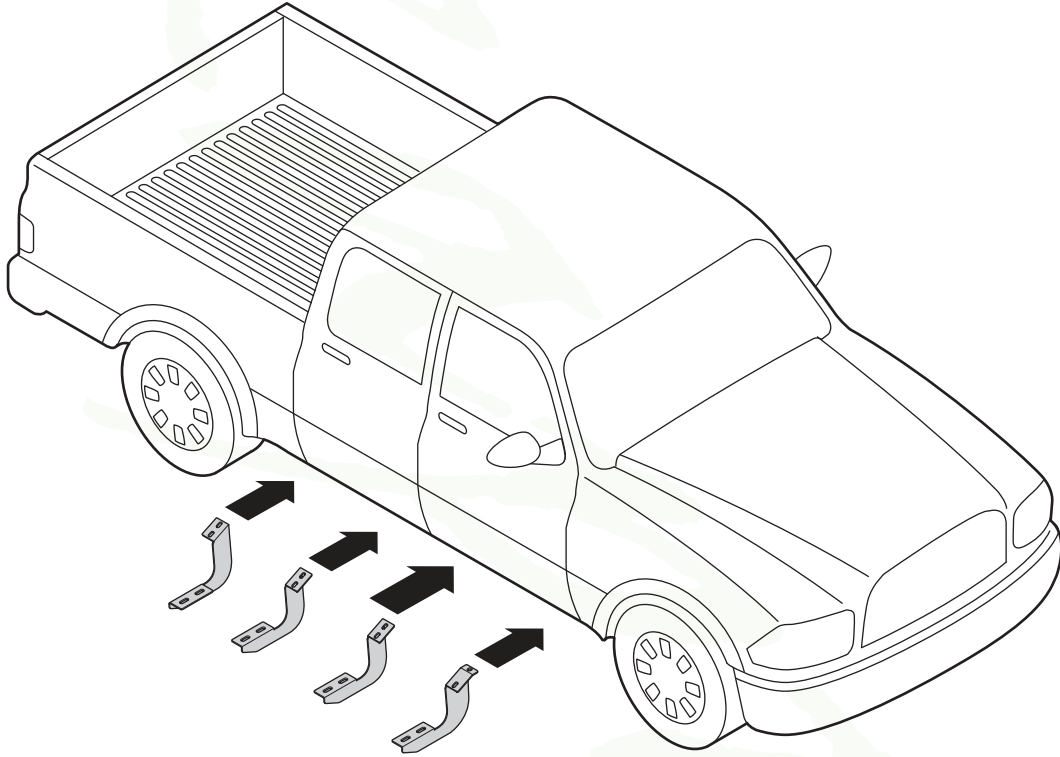

2. Passenger Side Front Bracket cradle (2a) and Passenger Side Center Bracket cradles (2b, 2c) will face toward the rear of the truck and the Passenger Side Rear Bracket cradle (2d) with face toward the front of the truck.

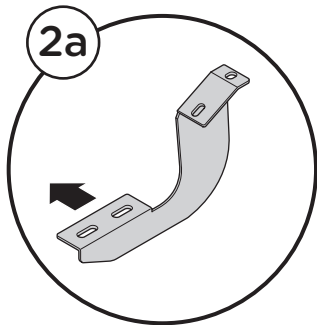

Passenger Side
Front Bracket

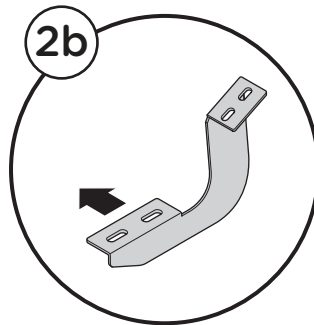

Passenger Side
Center Bracket

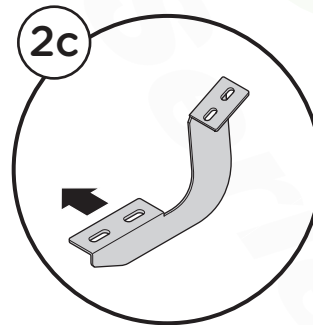

Passenger Side
Center Bracket

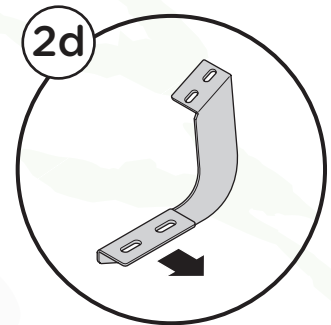

Passenger Side
Rear Bracket

BRACKET INSTALLATION

PASSENGER SIDE

Raptor
Series

4. Fasten the top portion of the Passenger Side Front Bracket by using (2) M8 x 30MM Hex Head Bolts, (2) M8 Flat Washers and (2) M8 Lock Washers.

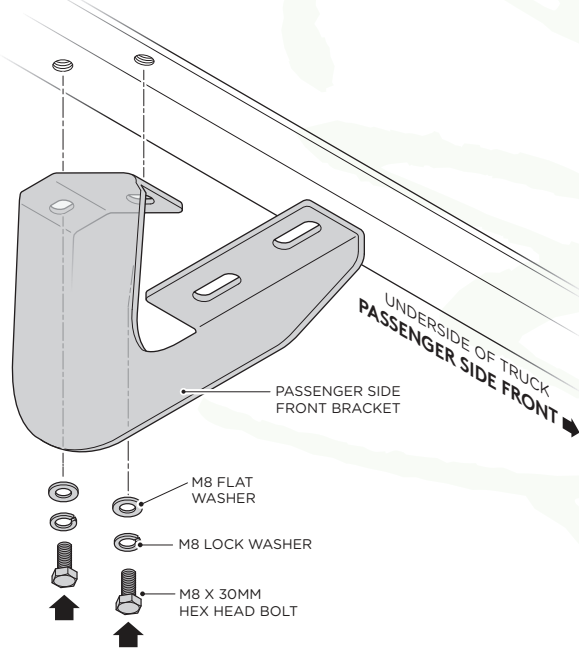

5. Fasten the top portion of the first Passenger Side Center Bracket by using (2) M8 x 30MM Hex Head Bolts, (2) M8 Flat Washers and (2) M8 Lock Washers.

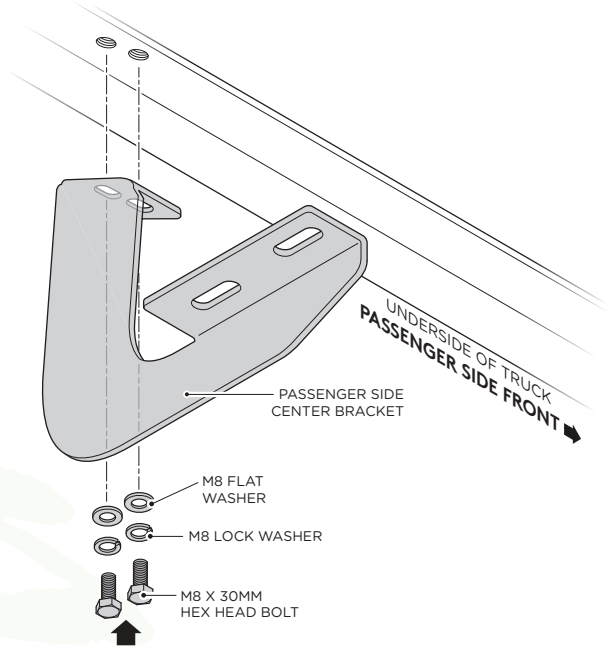

6. Fasten the top portion of the second Passenger Side Center Bracket by using (2) M8 x 30MM Hex Head Bolts, (2) M8 Flat Washers and (2) M8 Lock Washers.

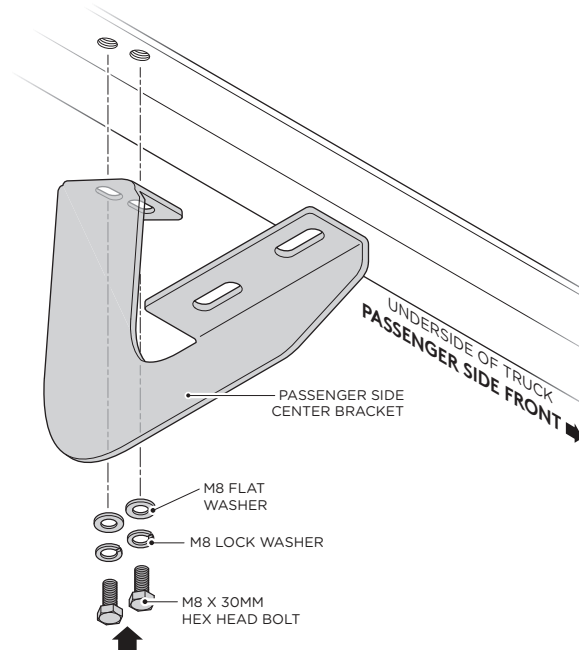

7. Fasten the top portion of the Passenger Side Rear Bracket by using (2) M8 x 30MM Hex Head Bolts, (2) M8 Flat Washers and (2) M8 Lock Washers.

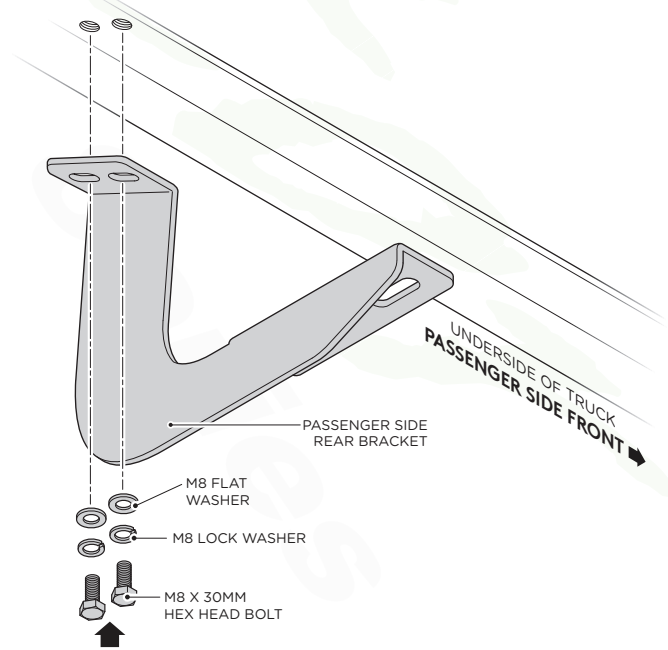

RUNNING BOARD INSTALLATION

PASSENGER SIDE



- 8.** Fasten the Running Board to the Passenger Side Front Bracket cradle by using (2) M8 Flat Washers and (2) M8 Lock Washers and (2) M8 Hex Head Nuts.

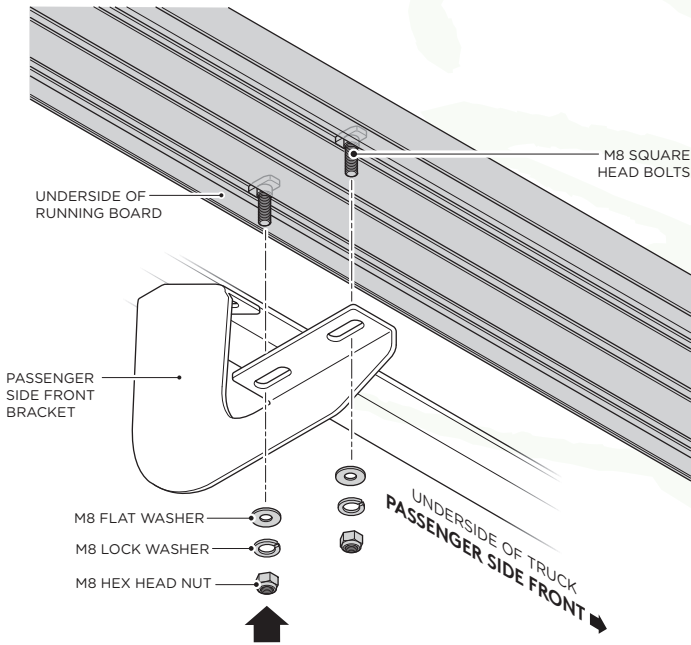

- 9.** Fasten the Running Board to the first Passenger Side Center Bracket cradle by using (2) M8 Flat Washers and (2) M8 Lock Washers and (2) M8 Hex Head Nuts.

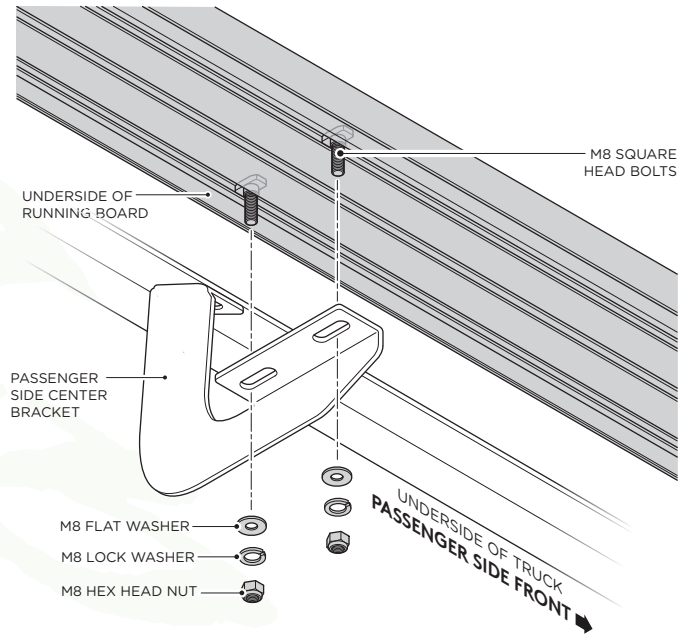

- 10.** To fasten the Running Board to the second Passenger Side Center Bracket cradle, insert (2) M8 Square Head Bolts (10a), then fasten using (2) M8 Flat Washers, (2) M8 Lock Washers

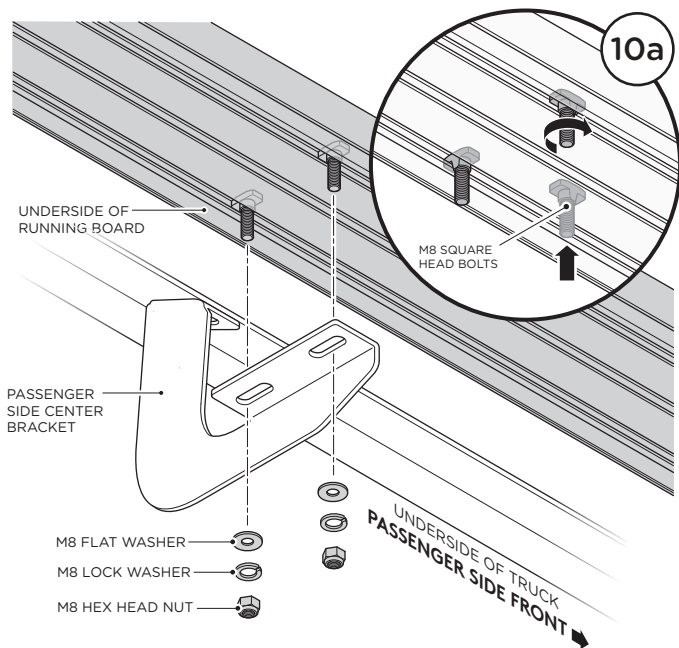

- 11.** Fasten the Running Board to the Passenger Side Rear Bracket cradle by using (2) M8 Flat Washers and (2) M8 Lock Washers and (2) M8 Hex Head Nuts.

