



AUTOMOTIVE PRODUCTS,

INSTALLATION INSTRUCTIONS

PRO TRAXX 4 & 5 OVAL TUBE STEP BAR

APPLICATION:

2009-2014 Ford F-150 Super Cab

2009-2014 Ford F-150 Super Crew

PART NUMBER:

21-23510, 21-23515, 21-23520, 21-23525,

21-53510, 21-53515, 21-53520, 21-53525

ITEM	QUANTITY	DESCRIPTION	TOOLS NEEDED
1,2	2	STEP BAR, DRIVER(1) AND PASSENGER(2)	13MM SOCKET
3	3	DRIVER MOUNT BRACKET (ONLY 2 FOR SUPER CREW)	17MM SOCKET
4	3	PASSENGER MOUNT BRACKET (ONLY 2 FOR SUPER CREW)	ALLEN KEY
5	1	DRIVER CENTER MOUNT BRACKET (ONLY FOR SUPER CREW)	RATCHET
6	1	PASSENGER CENTER MOUNT BRACKET (ONLY FOR SUPER CREW)	TORQUE WRENCH
7	12	M8 EXTRUDED U-NUT (YELLOW ZINC)	
8	24	M8 HEX CAP SCREW (YELLOW ZINC)	
9	12	SMALL M8 FLAT WASHER (YELLOW ZINC)	
10	24	LARGE M8 FLAT WASHER (YELLOW ZINC)	
11	24	M8 SPRING LOCK WASHER (YELLOW ZINC)	
12	12	M8 HEX NUT (YELLOW ZINC)	
13	12	M10 BUTTON HEAD SOCKET CAP SCREW (BLACK ZINC)	
14	12	M10 FLAT WASHER (BLACK ZINC)	
15	12	M10 INTERNAL TOOTHED LOCK WASHER (BLACK ZINC)	
16	12	M6 HEX HEAD CAP SCREW (YELLOW ZINC)	
17	24	M6 FLAT WASHER (YELLOW ZINC)	
18	12	M6 NYLON NUT (YELLOW ZINC)	
19	6	PLASTIC BRACKET COVER	

ANTI-SEIZE LUBRICANT MUST BE USED ON ALL STAINLESS STEEL FASTENERS TO PREVENT THREAD DAMAGE AND GALLING

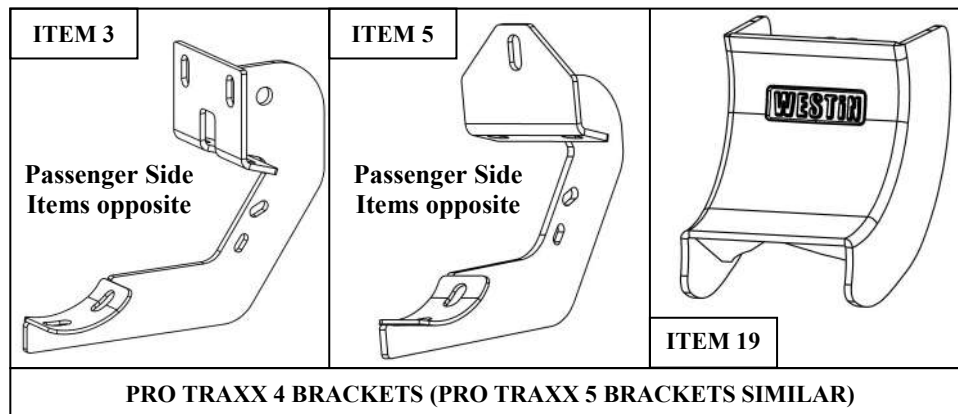

Westin Automotive Products, Inc.
320 W. Covina Blvd
San Dimas, Ca. 91773

Thank you for choosing Westin products
for additional installation assistance please call
Customer Service (800) 793-7846

PROCEDURE

1. Remove contents from box, verify if all parts listed are present and free from damage.

Carefully read and understand all instructions before attempting installation.

Failure to identify damage before installation could lead to a rejection of any claim.

2. Starting on the drivers side rocker panel, locate a piece of black tape. Remove the tape to reveal a rectangle hole. Take (2) M8 extruded u-nuts (Item 7) and place them over the two round holes located vertically into the rocker panel. See **Figure 1**.
3. Take the drivers side front mounting bracket (Item 3), and attach it to the previously installed M8 extruded u-nut using (2) M8 hex cap screws (Item 8), (2) M8 lock washers (Item 11), and (2) large M8 flat washers (Item 10). Do not fully tighten at this time, the cradles will face the rear of the vehicle. See **Figure 2**.

Remove tape and insert M8 extruded u-nuts over factory holes.



Figure 1

Attach the mounting bracket using M8 hardware.

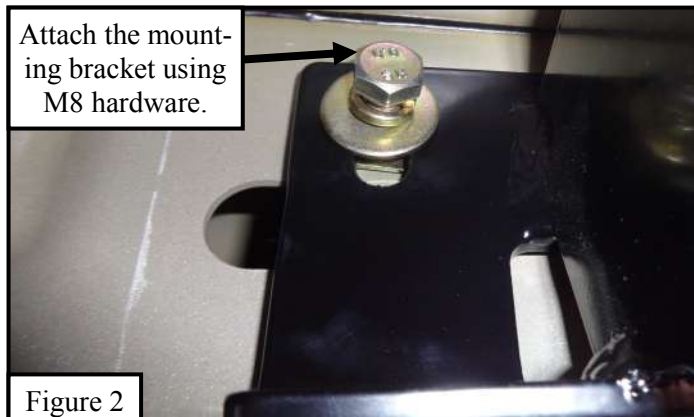

Figure 2

4. Attach the mounting bracket to the bottom holes in the rocker panel using (2) M8 hex cap screws (Item 8), (2) large M8 flat washers (Item 10), (2) small M8 flat washers (Item 9), (2) M8 lock washers (Item 11), and (4) M8 hex nuts (Item 12). Do not fully tighten at this time. See **Figures 4 and 5**.
5. Repeat **Steps 2-4** for the center and rear mounting brackets. For Super Crew P/N: 21-23520, 21-23525, 21-53520 & 21- 53525, the center brackets will mount only using (1) M8 extruded u-nuts (Item 7). See **Figure 3**.

Figure 3

Center mounting for Super Crew



(2) M8 hex head bolts,
(2) M8 large flat washers

Bracket shown is different but hardware used is the same.

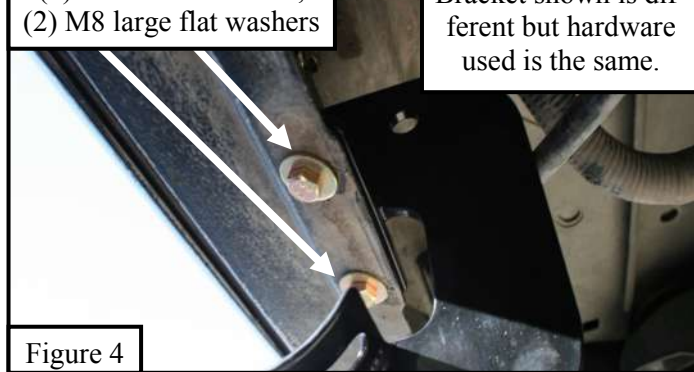

Figure 4

6. Locate Plastic Bracket Cover (Item 19) and install onto brackets using the provided M6 hardware (Items 16-18). (**Figure 6**)
7. Take the drivers side step bar and place it onto the mounting bracket cradles; align the step bars with the mounting holes in the brackets and attach using (6) M10 button head socket cap screws (Item 13), (6) M10 internal toothed lock washers (Item 15), and (6) M10 flat washers (Item 14). See **Figure 7**. Do not fully tighten at this time.
8. Align and adjust the step bar as needed then fully tighten all hardware at this time. Torque all M8 hardware to 15-18 ft-lbs, M10 stainless hardware to 30-35 ft-lbs, and M6 hardware to 5-7 ft-lbs.
9. Repeat **Steps 2-8** for the passenger side.



Westin Automotive Products, Inc.
320 W. Covina Blvd
San Dimas, Ca. 91773

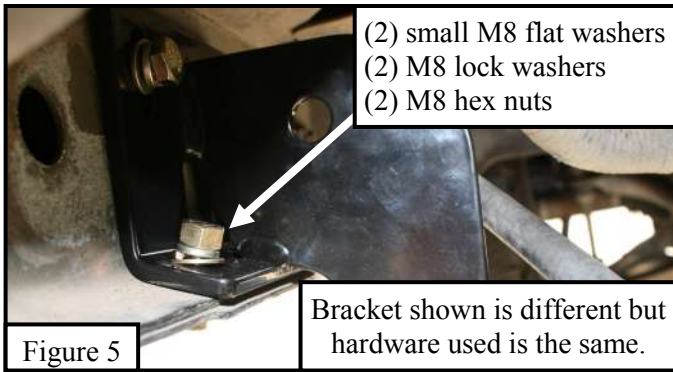

Figure 5

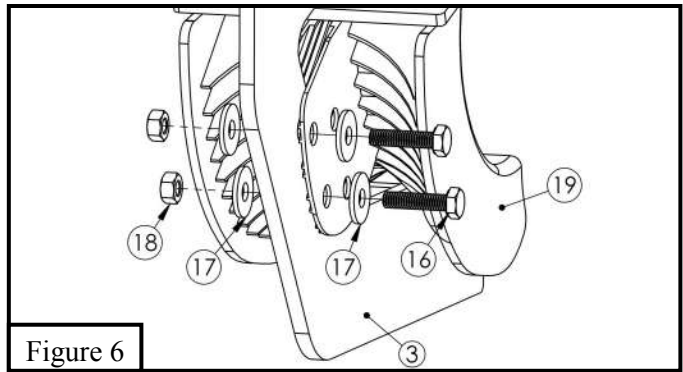

Figure 6

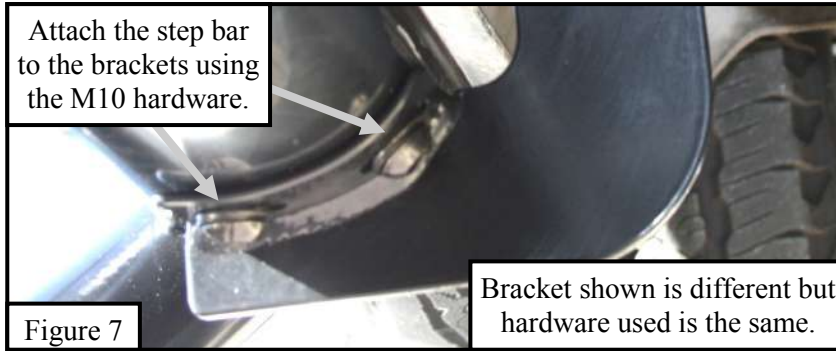
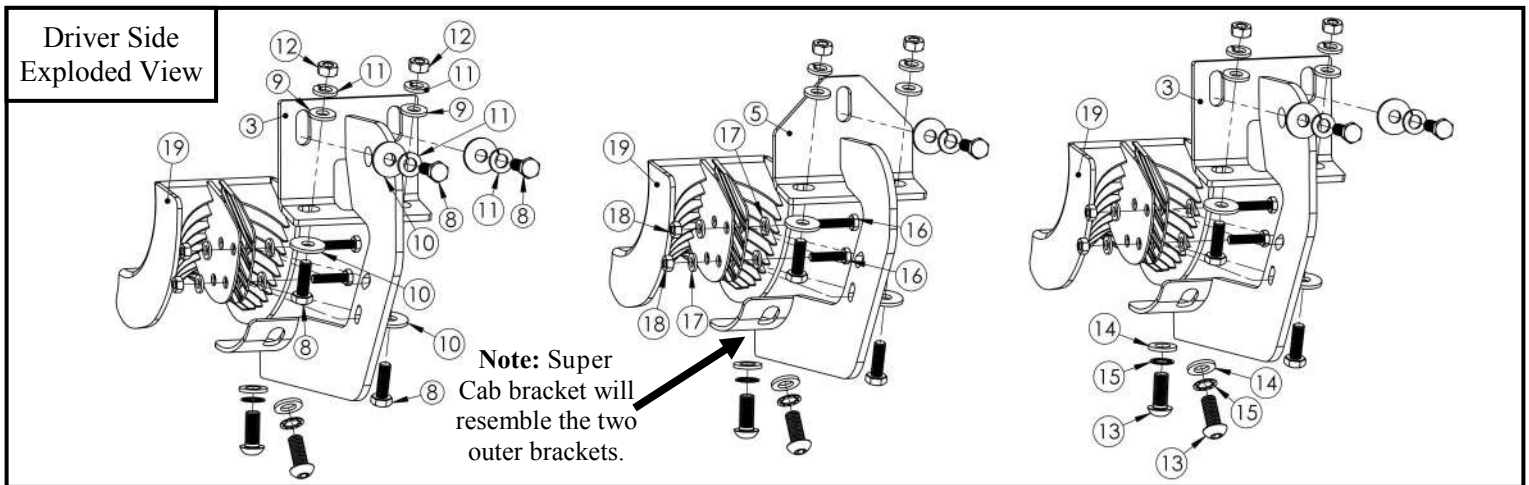

Figure 7



INSTALLATION COMPLETE



Care Instructions

- REGULAR WAXING IS RECOMMENDED. DO NOT USE ANY TYPE OF POLISH OR WAX THAT MAY CONTAIN ABRASIVES.
- STAINLESS STEEL PRODUCTS CAN BE CLEANED WITH MILD SOAP AND WATER. STAINLESS STEEL POLISH SHOULD BE USED TO POLISH SMALL SCRATCHES.
- GLOSS BLACK FINISHES SHOULD BE CLEANED WITH MILD SOAP AND WATER.



Westin Automotive Products, Inc.
320 W. Covina Blvd
San Dimas, Ca. 91773

Thank you for choosing Westin products
for additional installation assistance please call
Customer Service (800) 793-7846
www.westinautomotive.com

Westin

SIGNATURE OF QUALITY

AUTOMOTIVE PRODUCTS, INC.



WARNING



Failure to follow these instructions could lead to death, personal injury, and / or property damage.

FASTENERS:

All Westin supplied fasteners must be utilized and installed in accordance with the installation instructions and apply torque to the specifications as defined. **DOUBLE CHECK ALL FASTENERS BEFORE INITIAL USE, AND PERIODICALLY IN THE FUTURE TO ENSURE PROPER FUNCTION AND SAFETY.**

DRILLING:

Most Westin products do not require drilling for installation. If drilling is defined as required, use caution when drilling a vehicle. **FAILURE TO REVIEW AN AREA TO BE DRILLED MAY RESULT IN PERSONAL INJURY AND/OR INJURY TO OTHERS AS WELL AS VEHICLE DAMAGE.**

EYE PROTECTION:

ALWAYS WEAR SAFETY GLASSES OR GOGGLES DURING THE INSTALLATION PROCESS TO AVOID PERSONAL INJURY.

MAXIMUM TOWING/CARRYING CAPACITY:

The Westin Receiver Hitches will have a visible tow rating label affixed directly on the product. User should never exceed the vehicle manufacturers maximum tow and weight rating regardless of the capacity of the hitch. **FAILURE TO FOLLOW THESE GUIDELINES WILL VOID THE WESTIN WARRANTY AND MAY RESULT IN PERSONAL INJURY AND/OR INJURY TO OTHERS AS WELL AS VEHICLE DAMAGE.**

Westin
SIGNATURE OF QUALITY

Westin Automotive Products, Inc.
320 W. Covina Blvd
San Dimas, Ca. 91773