

## IARMOR EDGE™

PART#: IA-N004

### BEFORE INSTALLATION

REMOVE CONTENTS FROM BOX. VERIFY ALL PARTS ARE PRESENT. READ INSTRUCTIONS CAREFULLY BEFORE STARTING INSTALLATION. ASSISTANCE IS RECOMMENDED. THANK YOU FOR CHOOSING OUR PRODUCT!

\*BODY FRAME MOUNT

\*DRILLING/TRIMMING NOT REQUIRED

### Torque Value

Fastener Size	Tightening Torque (ft-lbs)	Required
6mm	6-7	√
8mm	16-18	X
10mm	31-32	X
12mm	56-58	X
14mm	92-94	X

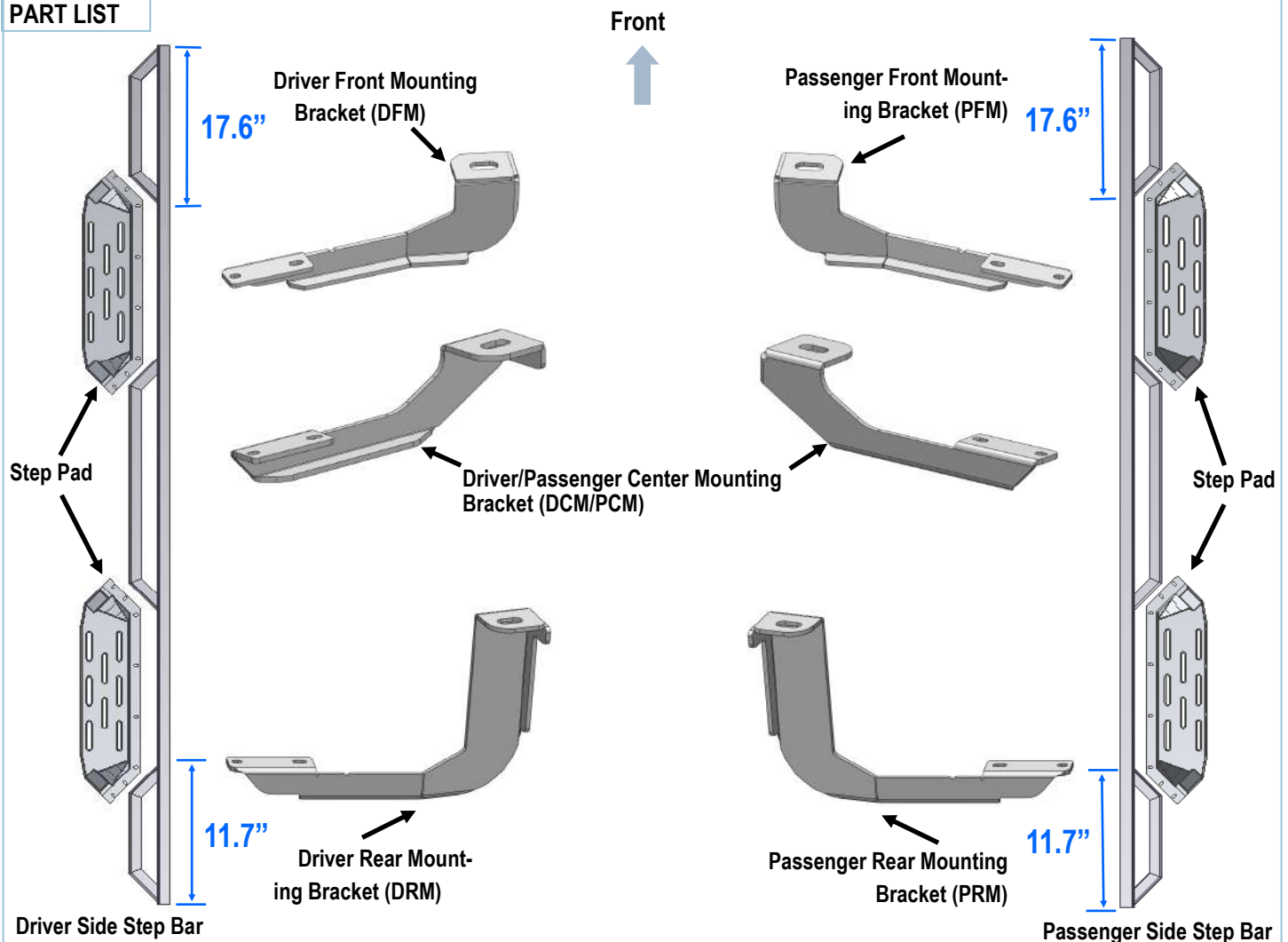

### PART LIST



Customer Support: [info@iarmorauto.com](mailto:info@iarmorauto.com)

# iArmor<sup>®</sup>

Hardware Package					
Item	QTY	Description	Item	QTY	Description
1#	44	M6X1-20 T- Bolts	3#	44	M6X1 Nylon Lock Nuts
2#	44	M6 Large Flat Washers			



1#                      2#                      3#

# iArmor®

The instruction here is for your reference only. We strongly recommend the professional installer for best result. We are not responsible for any damage caused by the installation.

## STEP 1

Install the Step Pads onto the step bars with (32) M6X1-20mm T-Bolts, (32) M6 Large Flat Washers and (32) M6X1 Nylon Lock Nuts.

**IMPORTANT:** Don't hit the step pad with any metal hammer within step pad installation, or the step pad will be damaged.

- (8) M6X1-20 T-Bolts
- (8) M6 Large Flat Washers
- (8) M6 Nylon Lock Nuts

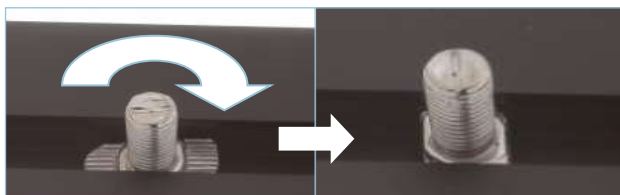

**Note: Rotate 90° after inserting the T-Bolts into the Channel!!!**

## STEP 2

Start the installation under the passenger side of the vehicle. Remove the front body mount bolt, (Fig 1). Do not remove rubber bushings.

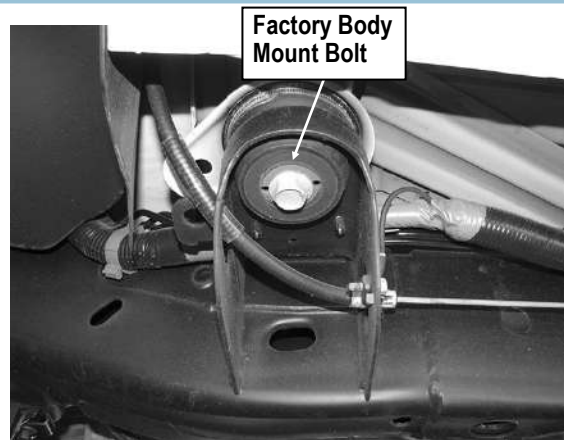

(Fig 1) Passenger Side Front Mounting Location

## STEP 3

Attach the Passenger Front Mounting Bracket (PFM) to the body mount reusing the factory hex bolt, (Fig 2). Do not fully tighten hardware at this time.

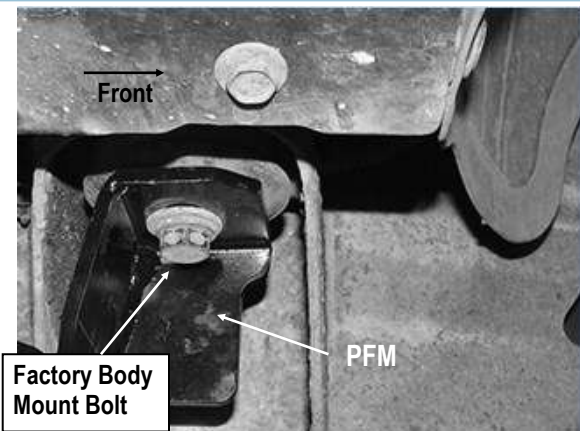

(Fig 2) Passenger Front Mounting Bracket Installed

# iArmor®

## STEP 4

Move to the passenger center body mount and remove the factory bolt. Select (1) Passenger Center Mounting Bracket (**DCM/PCM**). Repeat **Step 3** to attach the Passenger Center Mounting Bracket. Do not fully tighten hardware at this time.

**Note:** Passenger Center Mounting Bracket and Driver Center Mounting Bracket are universal.

## STEP 5

Continue on to the passenger side rear body mount. Repeat **Step 3** to Install the Passenger Rear Mounting Bracket (**PRM**), (**Fig 3**). Do not fully tighten hardware at this time.

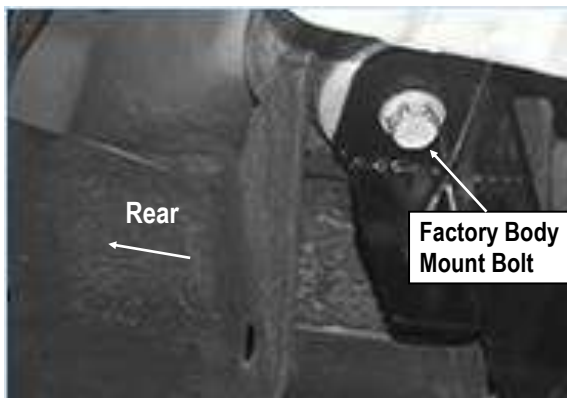

(Fig 3) Passenger Rear Mounting Bracket Installed

## STEP 6

Once all (3) Passenger side mounting brackets are installed, attach the assembled Passenger Side Bar to the Mounting Brackets with (6) M6X1-20 T-Bolts, (6) M6 Large Flat Washers and (6) M6X1 Nylon Lock Nuts, (**Fig 4**). Do not fully tighten hardware at this time.

## STEP 7

Properly level and adjust the Step Bar and fully tighten all hardware.

## STEP 8

Move to the driver side of the vehicle. Repeat **Steps 1-7** to install driver side step bar.

### Attention

Do periodic inspections to the installation to make sure that all hardware is secure and tight.

In order to protect your bars/boards, please use mild soap/non-abrasive products for cleaning only.

# iArmor<sup>®</sup>

(Fig 4) Passenger Side Step Bar Installation

