

iArmor[®]

iArmor[®] by APS

PART#: IA-S007H

BEFORE INSTALLATION

REMOVE CONTENTS FROM BOX. VERIFY ALL PARTS ARE PRESENT. READ INSTRUCTIONS CAREFULLY BEFORE STARTING INSTALLATION. ASSISTANCE IS RECOMMENDED. THANK YOU FOR CHOOSING OUR PRODUCT!

***BODY FRAME MOUNT**

***DRILLING NOT REQUIRED**

Torque Value

Fastener Size	Tightening Torque (ft-lbs)	Required
6mm	6-7	X
8mm	16-18	√
10mm	31-32	√
12mm	56-58	X
14mm	92-94	X

PART LIST

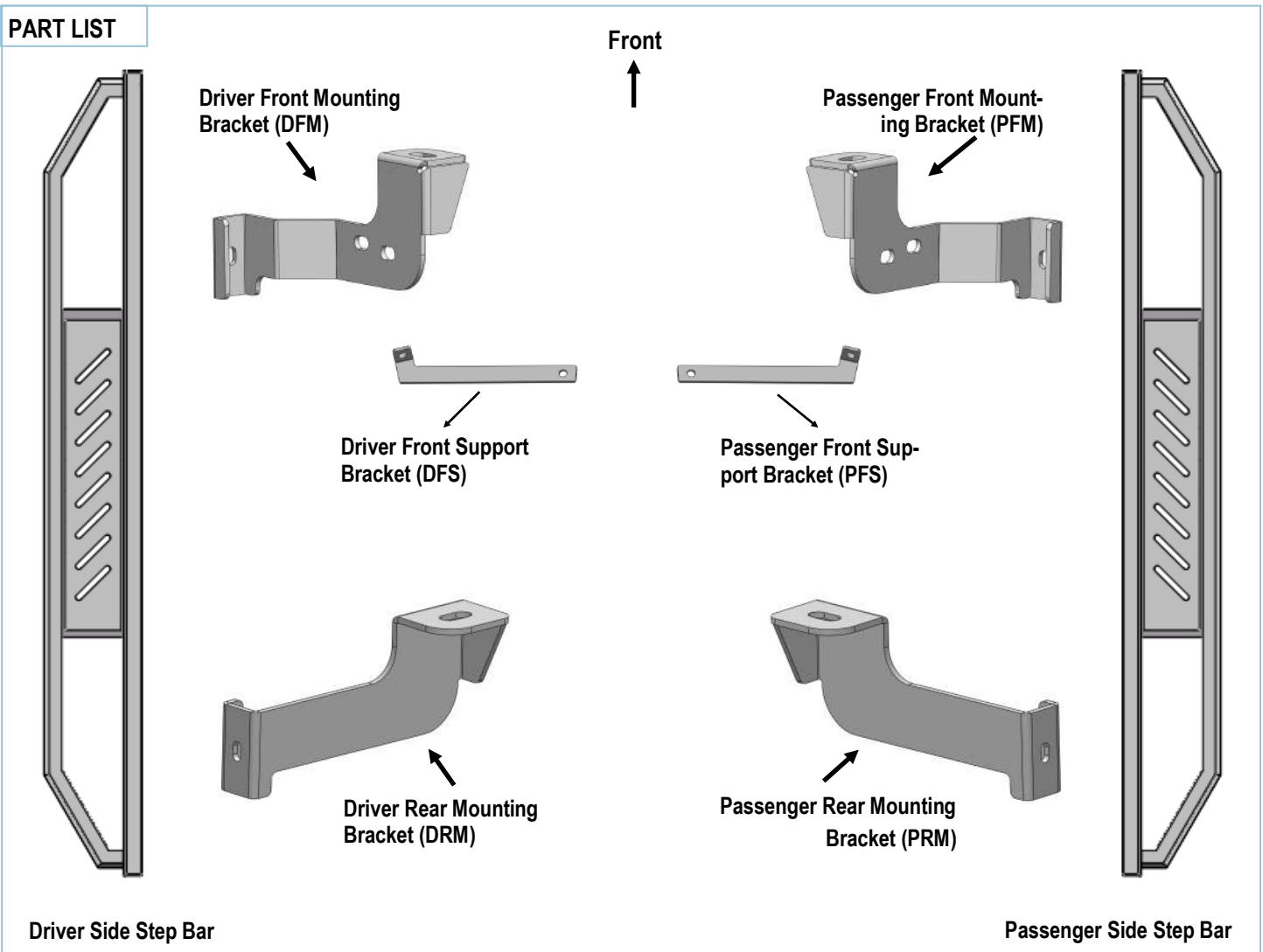

Customer Support: info@iarmorauto.com

iArmor®

Item	QTY	Description	Item	QTY	Description
1#	4	U Brackets	4#	6	M10 Flat Washers
2#	2	M10 Nut Plate	5#	4	M10 Lock Washers
3#	4	M10X1.5-30mm Hex Bolts	6#	2	M10 Hex Nuts

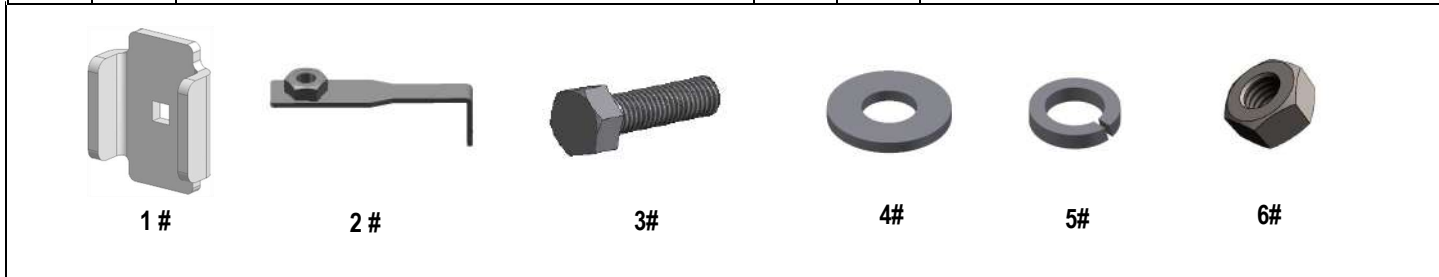

Hardware Package B (For Step Bar Installation)

Item	QTY	Description	Item	QTY	Description
1#	4	M8X1.25-55mm Carriage Bolts	3#	4	M8 Lock Washers
2#	4	M8 Large Flat Washers	4#	4	M8 Hex Nuts

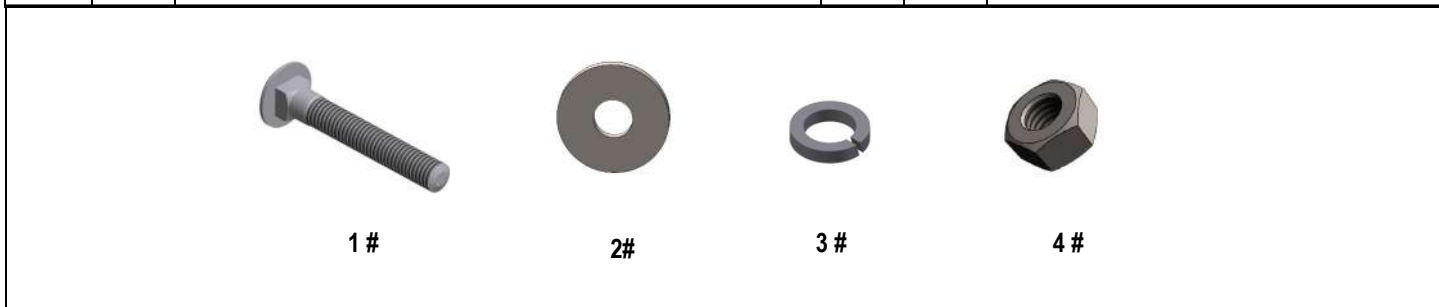

iArmor®

The instruction here is for your reference only. We strongly recommend the professional installer for best result. We are not responsible for any damage caused by the installation.

STEP 1

Start the installation under the Passenger side front of the vehicle. Remove the front body mount bolt, (Fig 1). Do not remove rubber bushings.

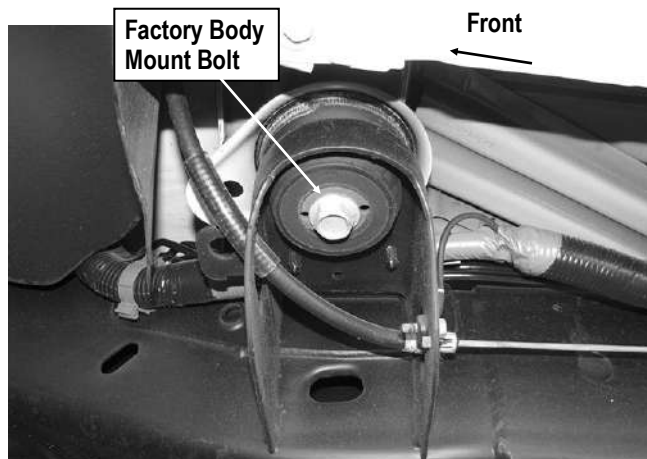

(Fig 1) Passenger Side Front Mounting Location

STEP 2

Attach the Passenger Front Mounting Bracket (PFM) to the body mount reusing the factory hex bolt, (Fig 2). Do not fully tighten hardware at this time.

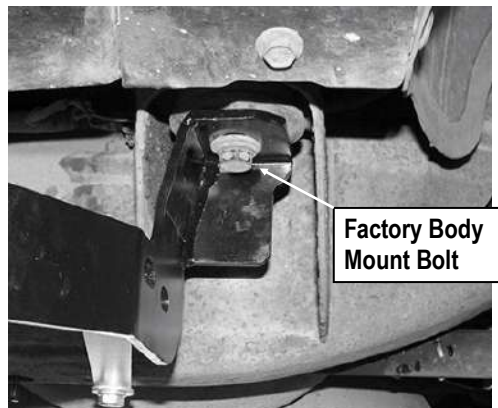

(Fig 2) Passenger Front Mounting Bracket (PFM) Installed

STEP 3

Locate the two factory holes at the bottom of the frame beside the passenger side front body mount, (Fig 3). Insert (1) M10 Nut Plate, (Fig 4), into the oval hole and line up the threaded nut with the round hole.

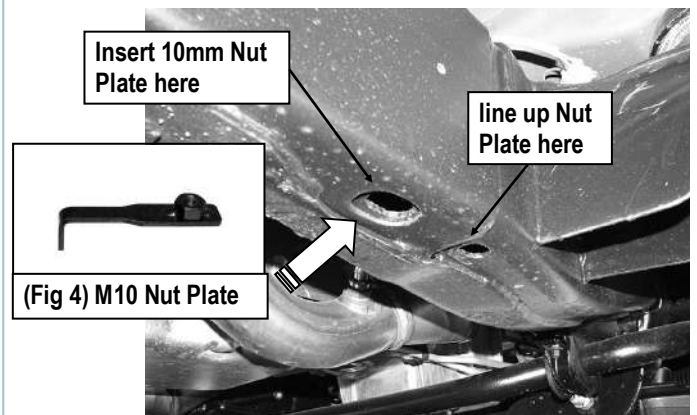

(Fig 3) Passenger Side Front Support Bracket Mounting Location

STEP 4

Attach the flat end of the Passenger Front Support Bracket (PFS) to the installed M10 Nut Plate with (1) M10X1.5-30mm Hex Bolt, (1) M10 Flat Washer and (1) M10 Lock Washer, (Fig 5 & 6). Do not fully tighten hardware at this time.

Up to 2007 2500/3500 Models:

Note that the Front Support Bracket will not reach up to the Mounting Bracket, (Fig 6). Tighten the Support Bracket to the M10 Nut Plate in the frame. Carefully push up on the Support Bracket until it reaches the inside hole in the Mounting Bracket. Bolt the Support Bracket to the hole in the Mounting Bracket with (1) M10X1.5-30mm Hex Bolt, (2) M10 Flat Washers, (1) M10 Lock Washer and (1) M10X1.5 Hex Nut, (Figs 5&7). Do not fully tighten hardware at this time.

NOTE: Bend Support Bracket up by hand to meet the inner hole in the Front Mounting Bracket.

iArmor®

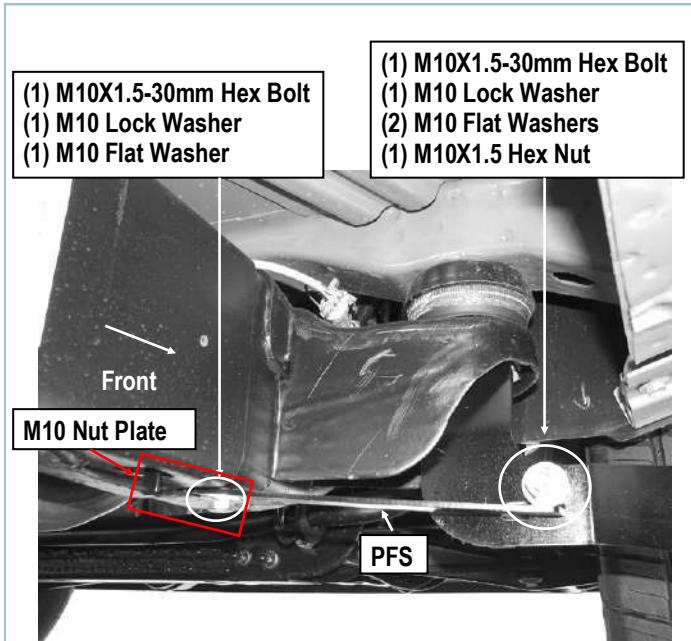

(Fig 5) Passenger Front Support Bracket (PFS) Installation
(For 1500 Models)

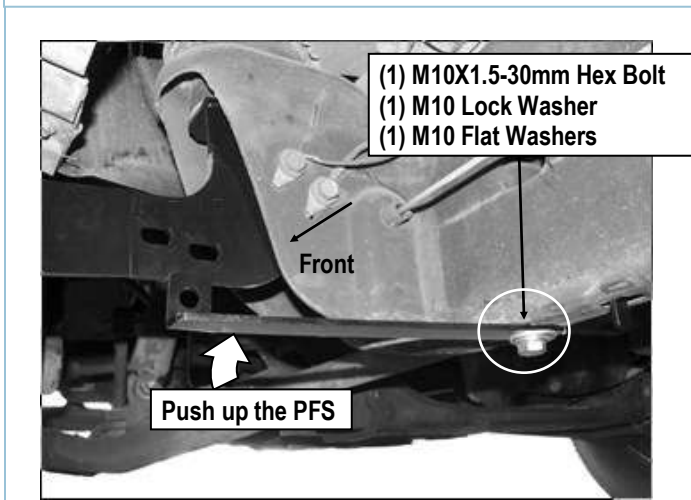

(Fig 6) Passenger Front Support Bracket Installation
(For Up to 2007 2500/3500 Models)

STEP 5

Move to the Passenger Side Rear body mount. Repeat **Steps 1-2** to install Passenger Rear Mounting Brackets (PRM). Don't fully tighten at this time.

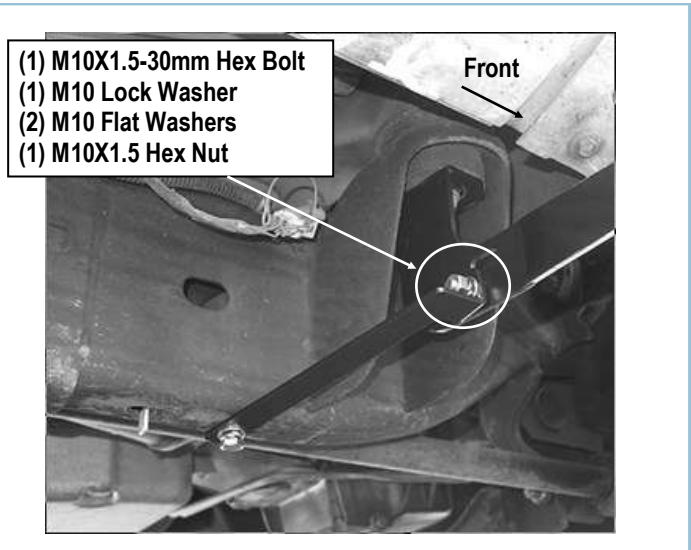

(Fig 7) Passenger Front Support Bracket Installation
(For Up to 2007 2500/3500 Models)

STEP 6

Once all (2) passenger side mounting brackets are installed, select and attach the Passenger Side Step Bar onto the Mounting Brackets with (2) U Brackets, (2) M8X1.25-55 Carriage Bolts, (2) M8 Large Flat Washers, (2) M8 Lock Washers and (2) M8X1.25 Hex Nuts (**Fig 8**). Do not fully tighten hardware at this time.

STEP 7

Properly level and adjust the Step Bar and fully tighten all hardware.

STEP 8

Move to the other side of the vehicle. Repeat **Steps 1-7** to install passenger side step bar.

Installation completed.

iArmor®

Attention

Do periodic inspections to the installation to make sure that all hardware is secure and tight.
In order to protect your bars/boards, please use mild soap/non-abrasive products for cleaning only.

NOTE: Torque all M8X1.25-55 Carriage Bolts to 16~18 lb-ft. Don't over tighten, or the square bars will be damaged by the brackets

