

iArmor®

IARMOR EDGE™

PART#: IA-W195

BEFORE INSTALLATION

REMOVE CONTENTS FROM BOX. VERIFY ALL PARTS ARE PRESENT. READ INSTRUCTIONS CAREFULLY BEFORE STARTING INSTALLATION. ASSISTANCE IS RECOMMENDED. THANK YOU FOR CHOOSING OUR PRODUCT!

*ROCKER PANEL MOUNT

*TRIMMING MAY BE REQUIRED

Torque Value

Fastener Size	Tightening Torque (ft-lbs)	Required
6mm	6-7	X
8mm	16-18	√
10mm	31-32	√
12mm	56-58	X
14mm	92-94	X

PART LIST

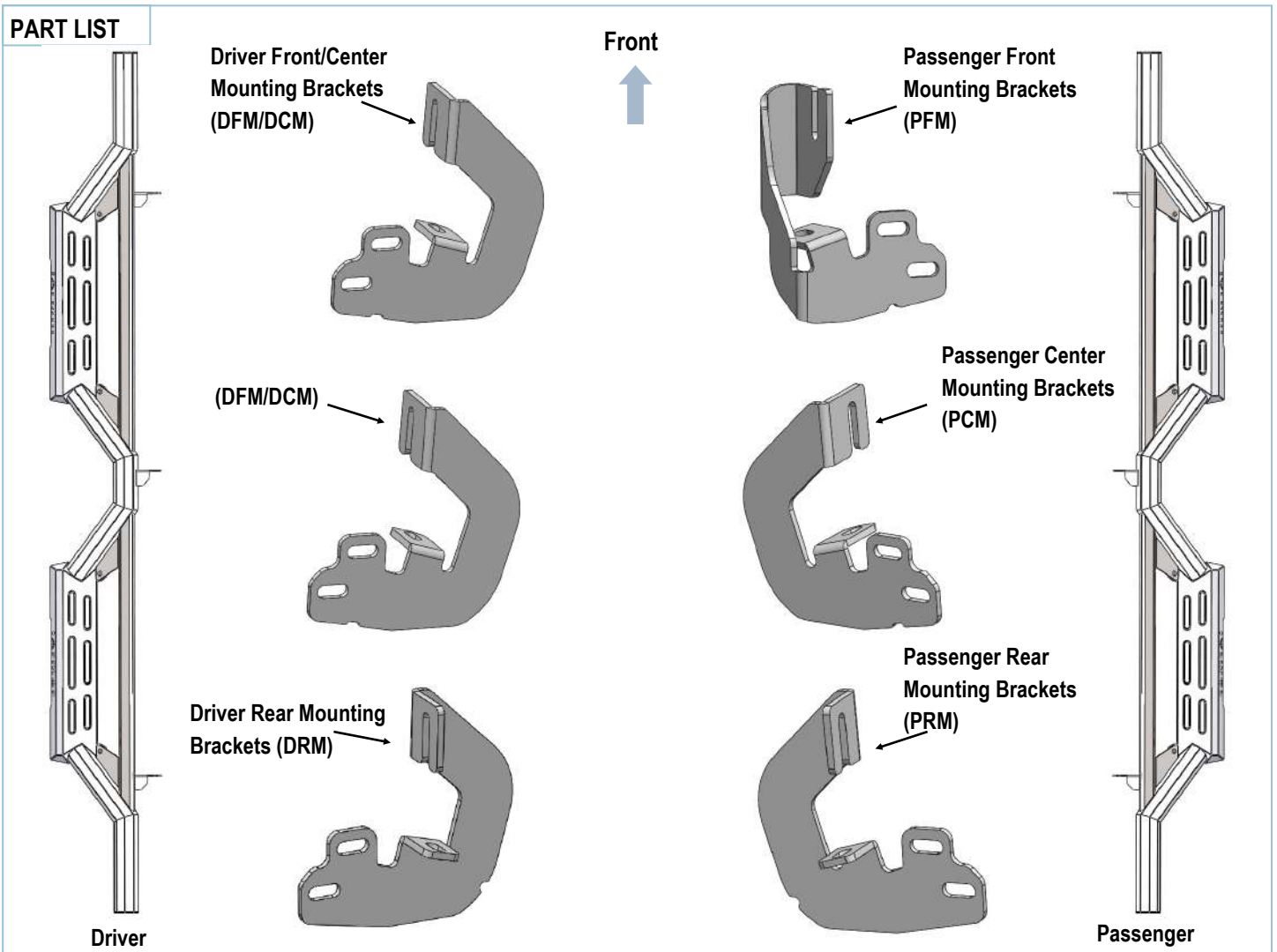

Customer Support: info@iarmorauto.com

iArmor[®]

Hardware Package (For Brackets & Step Bars Installation)

Item	QTY	Description	Item	QTY	Description
1#	12	M8X1.25-25 Hex Bolts	5#	12	M10X1.5-25 Hex Bolts
2#	12	M8 Large Flat Washers	6#	24	M10 Flat Washers
3#	12	M8 Lock Washers	7#	12	M10X1.5 Nylon Lock Nuts
4#	12	M8 Clip Nuts			

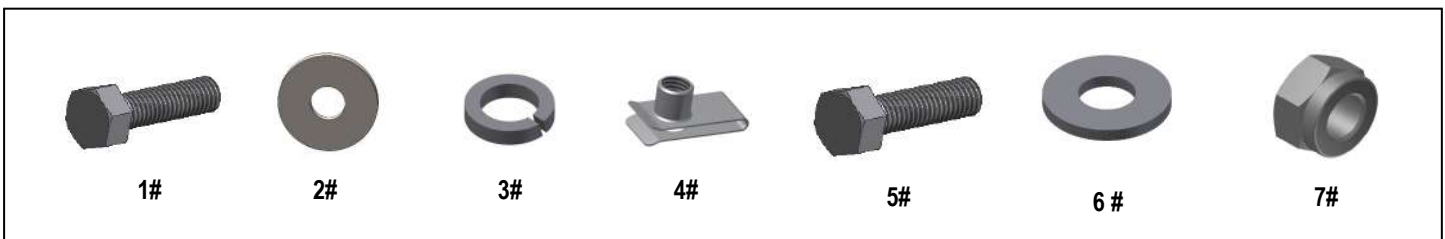

iArmor®

The instruction here is for your reference only. We strongly recommend the professional installer for best result. We are not responsible for any damage caused by the installation.

STEP 1

Start the installation under the driver side of the vehicle. Locate the 4 tabs along the bottom edge of the body, (pinch weld). Mounting Brackets will bolt to the 1st, 2nd and 4th mounting tabs, (Fig 1). Directly above each tab is a top mounting location on the side of the body panel. Hold a Bracket up in place to determine the mounting holes to use along the body.

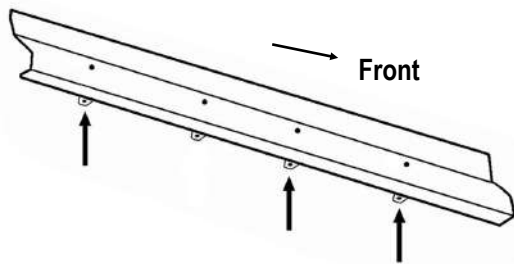

(Fig 1) Driver Side (3) Mounting Locations

STEP 2

Determine the correct procedure for your model/year and each Bracket location.

A. Bottom mounting location on the edge of the pinch weld.

- Flat tab on pinch weld with factory installed weld nut:** Thread the M8X1.25-25 Hex Bolt into the weld nut from the backside down to clear paint from threads, (Fig 2).
- Flat tab on pinch weld with hole:** Select (1) M8 Clip Nut. Slide the Clip Nut over the tab with the nut facing up, (Figs 3-5). Repeat for each mounting location.

B. Top mounting location on the back side of the body panel.

- Models with factory installed threaded insert in body panel:** Thread M8X1.25-25 Hex Bolt into threaded insert to clear paint as required, (Figs 2 & 3).
- Models with large and small hole on the body panel:** Remove the rubber plug from the larger hole if equipped. Select (1) M8 Clip Nut. Slide the Clip Nut into the larger hole. Line up the threaded nut with the smaller hole, (Figs 4 & 5).

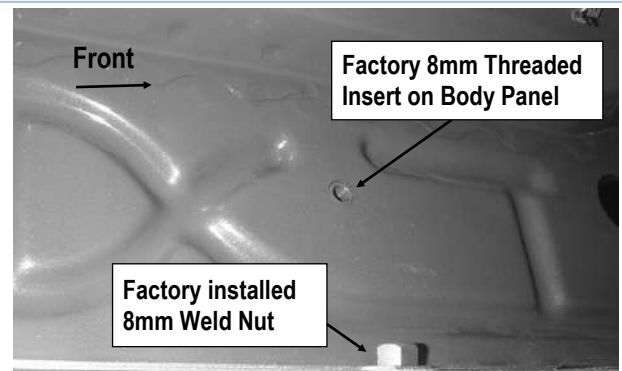

(Fig 2) Flat tab on Pinch Weld with Factory Installed Weld Nut (Driver Side Front Mounting Location)

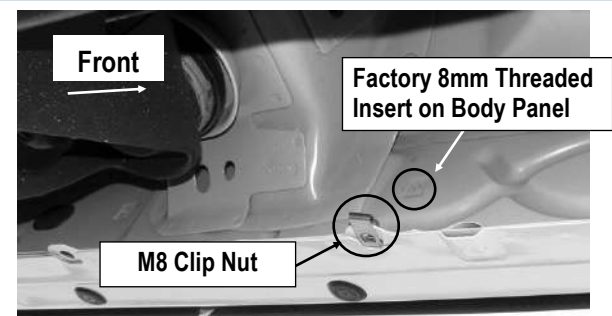

(Fig 3) Flat tab on Pinch Weld with hole (Driver Side Center Mounting Location)

iArmor[®]

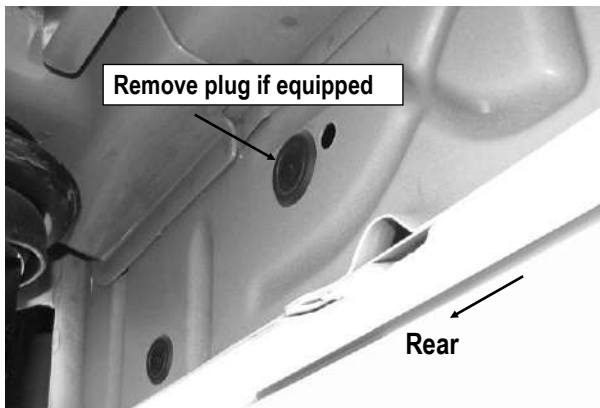

(Fig 4) Large and small holes on the body panel (Driver Side Rear Mounting Location)

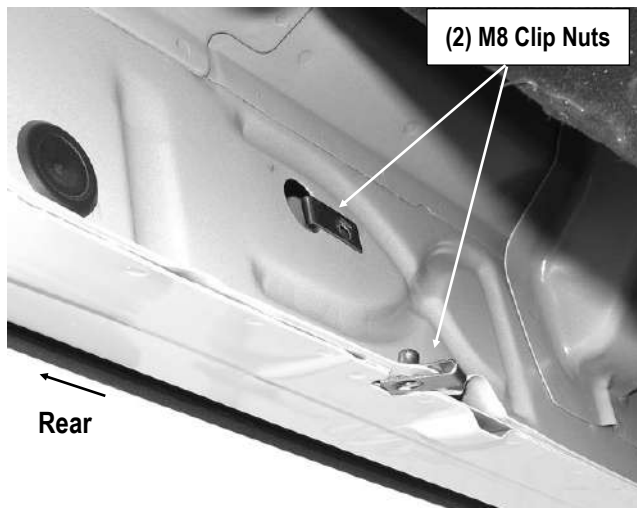

(Fig 5) Driver Side Rear Mounting Location

STEP 3

Select (1) Driver Front Mounting Bracket (**DFM/DCM**). Attach bracket to the driver side front mounting location with (2) M8X1.25-25 Hex Bolts, (2) M8 Lock Washers and (2) M8 Large Flat Washers, (**Figs 6-7**). Do not fully tighten hardware at this time.

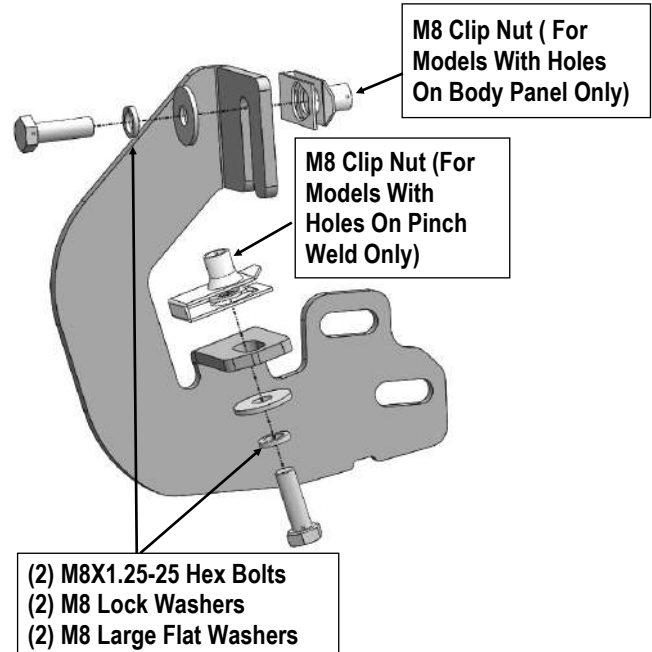

(Fig 6) Driver Front Mounting Bracket Installation

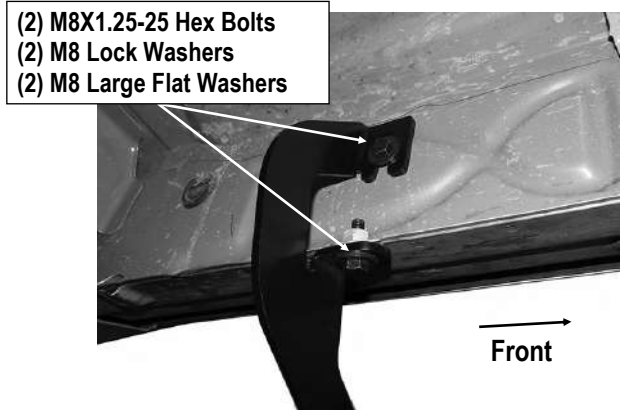

(Fig 7) Driver Front Mounting Bracket Installed

STEP 4

Repeat **Steps 1-3** to install the (2) remaining driver side Brackets. Do not fully tighten hardware at this time.

iArmor®

STEP 5

Once all (3) driver side brackets are installed, attach the Driver Side Step Bar on the Mounting Brackets with (6) M10X1.5-25 Hex Bolts, (12) M10 Flat Washers and (6) M10X1.5 Nylon Lock Nuts, (**Fig 8**). Do not fully tighten hardware at this time.

Properly level and adjust the Step Bar and then fully tighten all hardware.

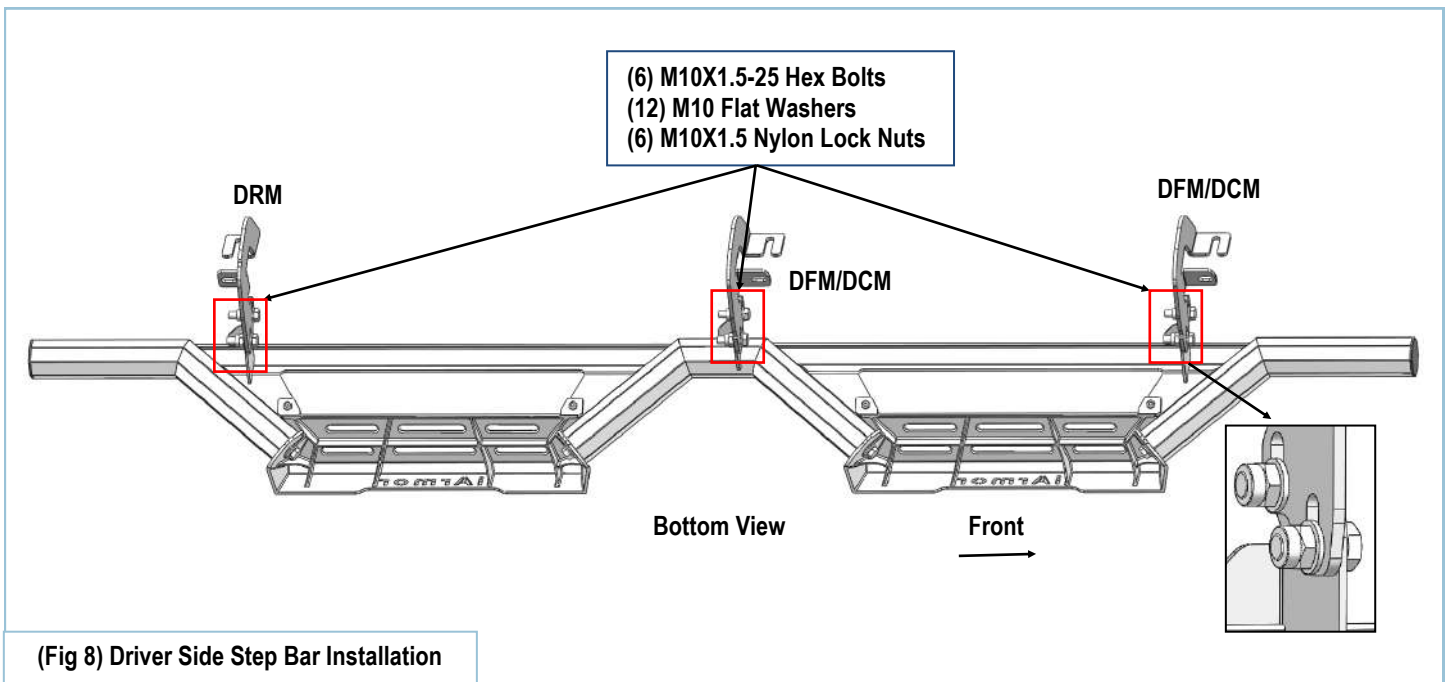

iArmor®

STEP 6

Move to the passenger side of the vehicle. On the passenger side, determine if the vehicle is equipped with a plastic diesel exhaust fluid (DEF) tank, (Fig 9 & 10).

- ◆ **Models without DEF tank, skip to Step 7.**
- ◆ **Models with DEF tank, first determine correct procedure for your model/year:**
 - **2007-2016 Models with DEF tank:**

The tank sits close to the side of the body. With specialized tools, the Passenger Front Mounting Bracket can be installed but room is limited. It may be easier to drop the tank down to access the inner side of the body panel to mount the bracket. Tank will not need to be removed, only dropped down for access to mounting location.

IMPORTANT: If tank is full, it will be very heavy and assistance is highly recommended to avoid injury or damage to the vehicle or the tank. It is recommended that installation is performed when the DEF tank is low on fluid before dropping the tank.

 - a. On models with plastic lower tray under the tank, remove the (3) hex bolts attaching the tray to the frame, (Fig 9), and remove the tray.
 - b. Release the tank filler hose. Release the plug for the sending unit on the top of the tank.
 - c. Support the tank with a floor jack. Place a smooth flat surface, (wooden block for example), between the floor jack and the tank to avoid damaging the plastic tank. Do not push up on the tank; only support the weight of the tank with the jack.
 - d. Remove the (2) bolts securing the tank straps to the vehicle, (Fig 11). Tilt the straps to release from the brackets. Slowly lower the tank until the top of the tank is almost visible. Use blocks or stands to support the tank while installing the front Brackets.
 - e. Proceed to **Step 7**.
 - **2017- On 2500/3500 models:**

Do not remove the tank. Remove the (4) hex bolts attaching the plastic cover to DEF tank, (Fig 10A) and remove only the plastic cover, (Fig 10B).

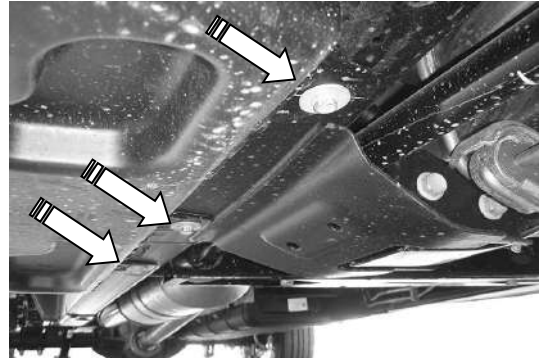

(Fig 9) 07-16 Passenger side front pictured with DEF tank cover. Remove (3) hex bolts to remove cover

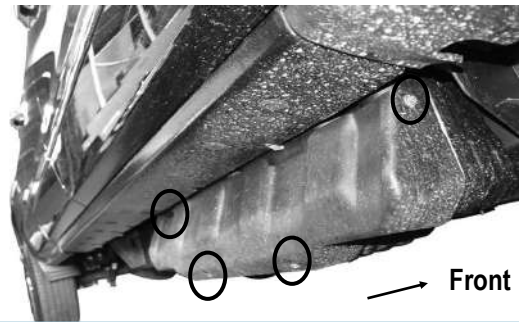

(Fig 10A) 2017-On Passenger side pictured with DEF plastic tank cover. Remove (4) hex bolts to remove plastic cover



(Fig 10B) 2017-On Passenger side DEF cover removed

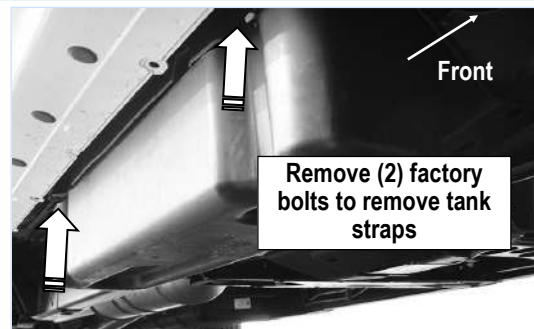

(Fig 11) 07-16 Passenger side DEF tank and cover

STEP 7

Locate the first tab on the edge of the pinch weld, (Figs 2-5). Select the Passenger Front Mounting Bracket:

A. Secure the mounting bracket to the body panel:

- a. **For models with threaded insert in body panel, (Figs 2 & 3).** Attach the mounting bracket to the body panel with (1) M8X1.25-25 Hex Bolt, (1) M8 Lock Washer and (1) M8 Flat Washer, (Fig 12).
- b. **For models with Large and small holes in the body panel, (Figs 4 & 5).** Select (1) M8 Clip Nut into the large hole and line up the threaded nut over the small hole. Attach the mounting bracket to the body panel with (1) M8X1.25-25 Hex Bolt, (1) M8 Lock Washer and (1) M8 Large Flat Washer, (Fig 12).

B. Secure the mounting bracket to the pinch weld:

- a. **For models flat tab on pinch weld with a weld nut, (Fig 2).** Attach the mounting bracket to the body panel with (1) M8X1.25-25 Hex Bolt, (1) M8 Lock Washer and (1) M8 Large Flat Washer, (Fig 12).
- b. **For models flat tab on pinch weld with hole, (Figs 3-5).** Attach the mounting bracket to the body panel with (1) M8X1.25-25 Hex Bolt, (1) M8 Lock Washer and (1) M8 Large Flat Washer, (Fig 12).

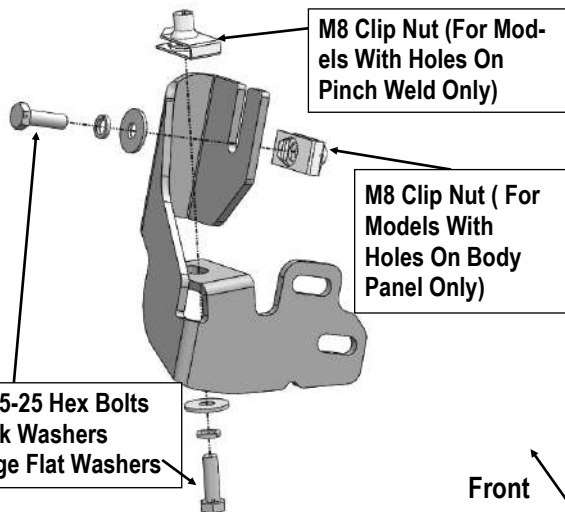

(Fig 12) Passenger Front Mounting Bracket Installation

STEP 8

Repeat **Steps 1-3** for the (2) remaining passenger side Brackets installation.

2017-On 2500/3500 DEF tank models: Locate the 2nd tab bracket location along the bottom edge of the body, (pinch weld), (Fig 13). Hold the DEF cover in place and mark the 2nd Bracket location onto the cover, (Fig 14). Use a sharp knife or hacksaw blade to carefully cut a slot in the plastic cover to clear the 2nd Bracket, (Fig 15). Remove as little plastic as possible.

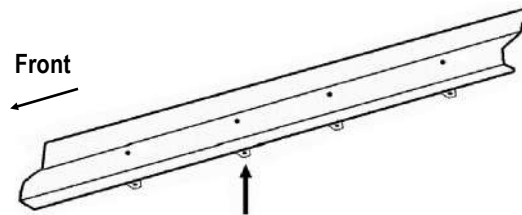

(Fig 13) Passenger side 2nd bracket location from back of body panel



(Fig 14) 2017-On Passenger side DEF cover marked for trimming

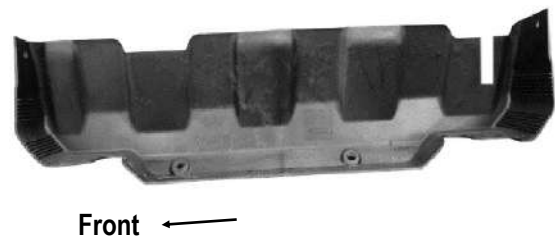

(Fig 15) 2017-On Passenger side DEF cut for example only

iArmor[®]

STEP 9

Repeat **Steps 5** to install the passenger Side Step Bar.

STEP 10

Once the Step Bar has been installed and all hardware fully tightened, reinstall the DEF tank and cover, if equipped, as described in **Step 6**.

Installation completed.

Attention

Do periodic inspections to the installation to make sure that all hardware is secure and tight.

In order to protect your bars/boards, please use mild soap/ non-abrasive products for cleaning only.