

# iArmor®

## IARMOR EDGE™

PART#: IA-W295

### BEFORE INSTALLATION

REMOVE CONTENTS FROM BOX. VERIFY ALL PARTS ARE PRESENT. READ INSTRUCTIONS CAREFULLY BEFORE STARTING INSTALLATION. ASSISTANCE IS RECOMMENDED. THANK YOU FOR CHOOSING OUR PRODUCT!

\*ROCKER PANEL MOUNT

\*DRILLING/TRIMMING NOT REQUIRED

### Torque Value

Fastener Size	Tightening Torque (ft-lbs)	Required
6mm	6-7	X
8mm	16-18	√
10mm	31-32	√
12mm	56-58	X
14mm	92-94	X

Driver

Front  
↑

Passenger

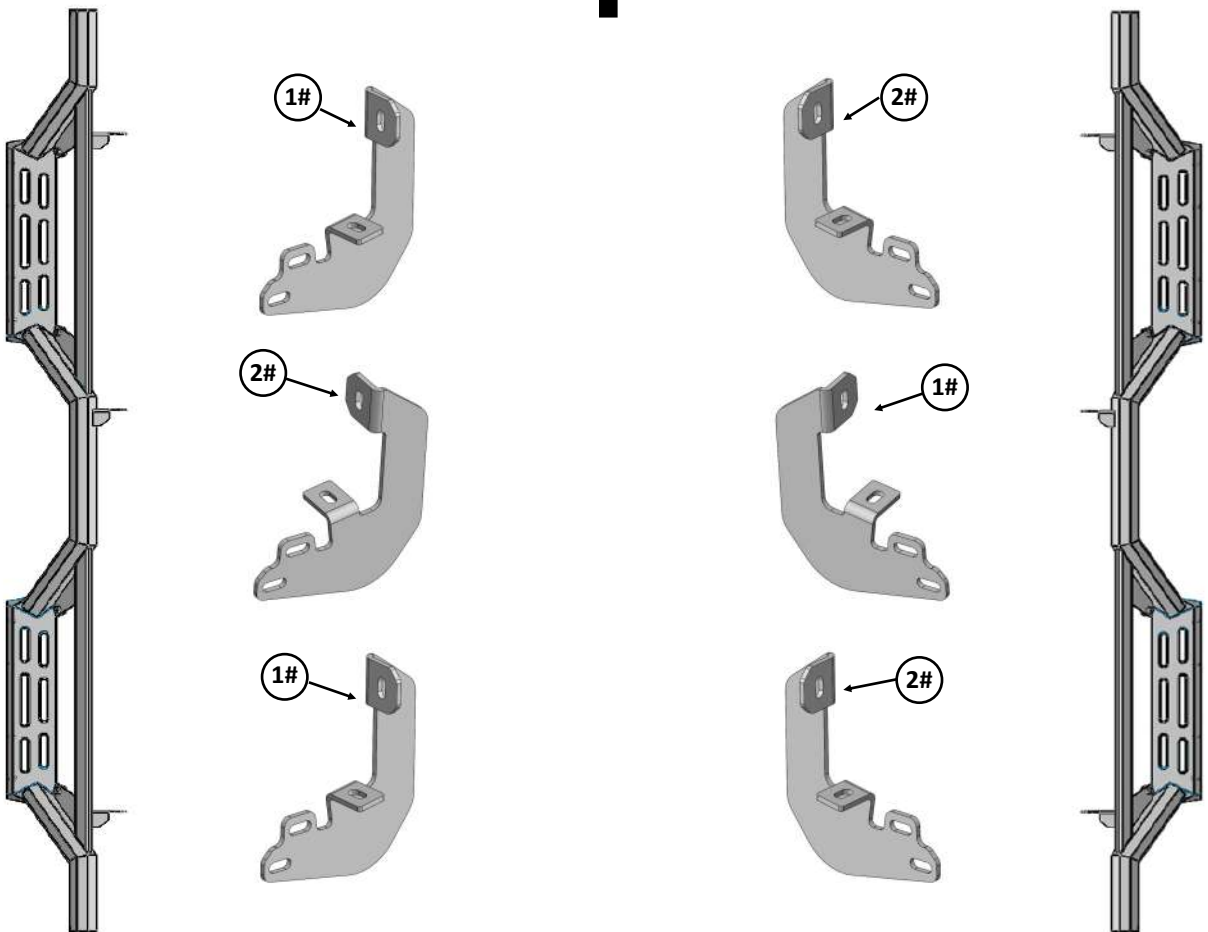

Customer Support: [info@iarmorauto.com](mailto:info@iarmorauto.com)

# iArmor<sup>®</sup>

## Hardware Package (For Brackets & Step Bars Installation)

Item	QTY	Description	Item	QTY	Description
1#	3	Driver Front & Rear / Passenger Center Mounting Brackets	5#	12	M8 Lock Washers
2#	3	Passenger Front & Rear / Driver Center Mounting Brackets	6#	12	M10X1.5-25 Hex Bolts
3#	12	M8X1.25-30 Hex Bolts	7#	24	M10 Flat Washers
4#	12	M8 Large Flat Washers	8#	12	M10 Nylon Lock Nuts



3#



4#



5#



6#



7#



8#

# iArmor®

The instruction here is for your reference only. We strongly recommend the professional installer for best result. We are not responsible for any damage caused by the installation.

## STEP 1

Start the installation on the driver side of the vehicle. Locate the 6 plugs along the bottom of the body panel. Mounting Brackets will bolt to the **1st, 3rd and 6th** threaded mounting holes. Remove the plastic plugs from each mounting location, (Fig 1).

It will be helpful for Identifying the mounting locations by holding up Brackets in place, (Figs 3-5).

**NOTE: Thread an M8 Hex Bolt into the threaded inserts to clear paint as required.**

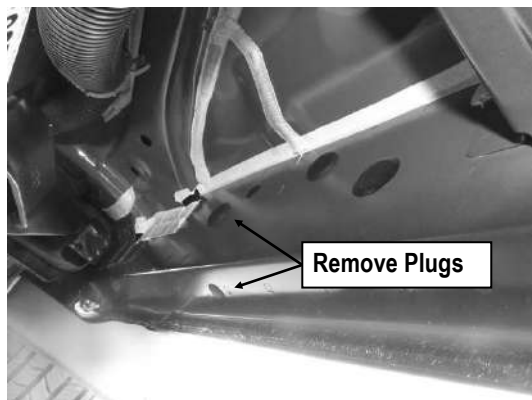

(Fig 1) Remove Rubber Plugs

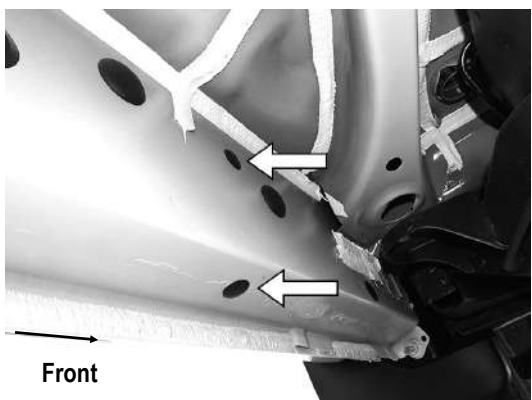

(Fig 2) Driver Side Front Mounting Location

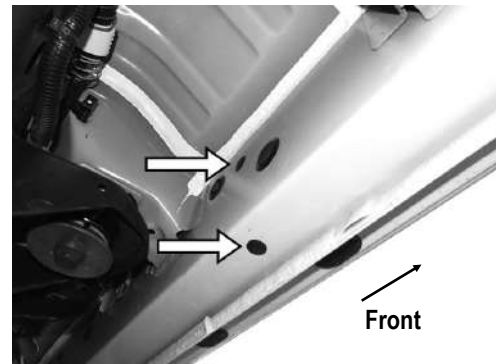

(Fig 3) Driver Side Center Mounting Location

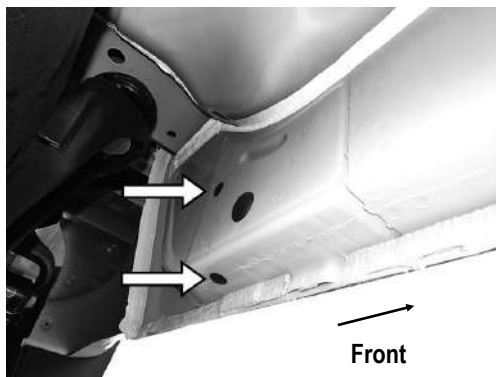

(Fig 4) Driver Side Rear Mounting Location

## STEP 2

Attach (1) Driver Front Mounting Bracket to the factory threaded holes on the Front Mounting Location with (2) M8X1.25-30mm Hex Bolts, (2) M8 Lock Washers and (2) M8 Large Flat Washers, (Figs 5,6). Do not tighten hardware at this time.

Repeat to install other (2) Driver Side Mounting Brackets. Do not tighten hardware at this time.

**Note: Driver Center Mounting Bracket is different with Driver Front and Rear Mounting Brackets.**

## STEP 3

Once all (3) Driver Side Mounting Brackets have been installed, attach the Passenger Side Step Bar to the Mounting Brackets using (6) M10X1.5-25 Hex Bolts, (12) M10 Flat Washers and (6) M10X1.5 Nylon Lock Nuts, (Fig 7). Do not fully tighten hardware at this time.

# iArmor®

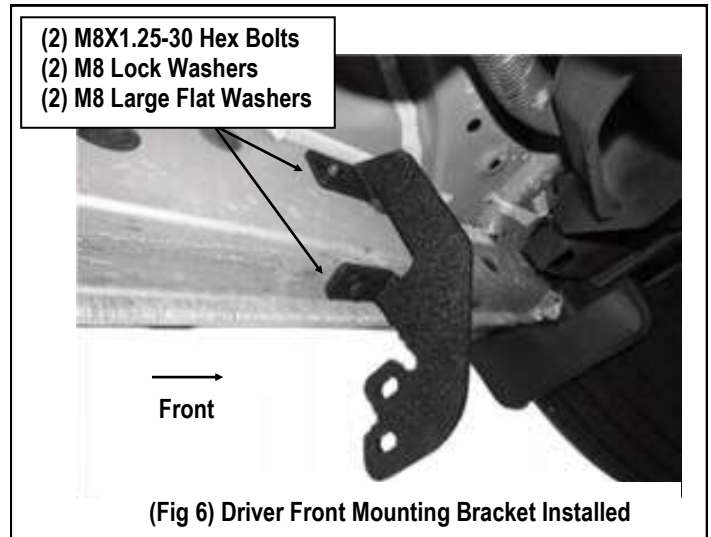
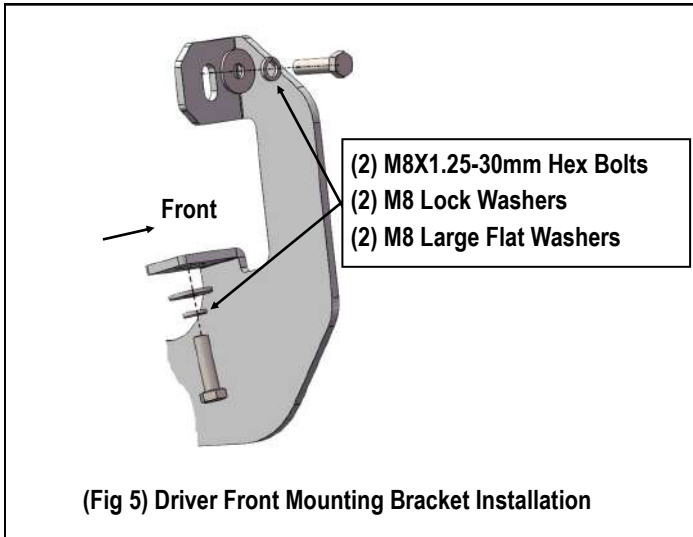

## STEP 4

Properly level and adjust the Step Bar and fully tighten all hardware.

## STEP 5

Move to the other side of the vehicle. Repeat **Steps 1-4** for the other Side Step Bar installation.

### Attention

Do periodic inspections to the installation to make sure that all hardware is secure and tight.

In order to protect your bars/boards, please use mild soap/non-abrasive products for cleaning only.

