

iArmor®

IARMOR EDGE™

PART#: IA-W175

BEFORE INSTALLATION, REMOVE CONTENTS FROM BOX. VERIFY ALL PARTS ARE PRESENT. READ INSTRUCTIONS CAREFULLY BEFORE STARTING INSTALLATION. ASSISTANCE IS RECOMMENDED. THANK YOU FOR CHOOSING OUR PRODUCT!

*ROCKER PANEL MOUNT

*DRILLING/TRIMMING NOT REQUIRED

Fastener Size	Tightening Torque (ft-lbs)	Required
6mm	6-7	X
8mm	16-18	√
10mm	31-32	√
12mm	56-58	X
14mm	92-94	X

Driver

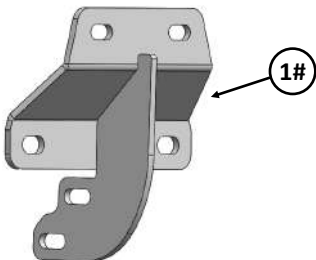
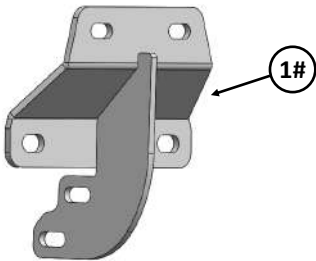
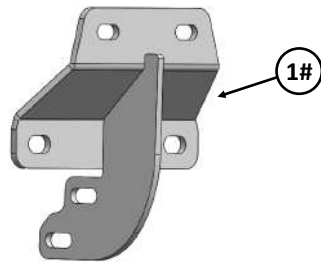
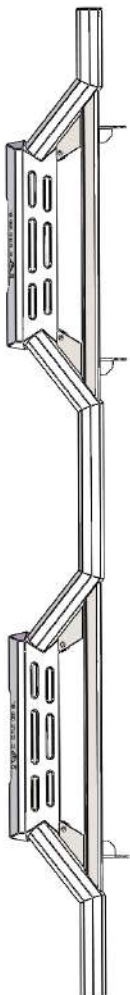

Front

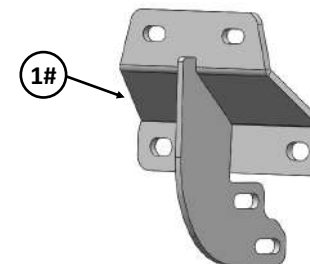
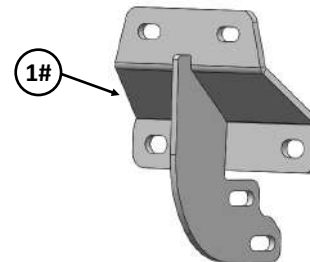
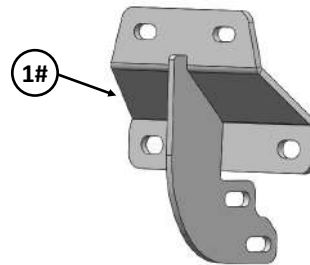

Passenger

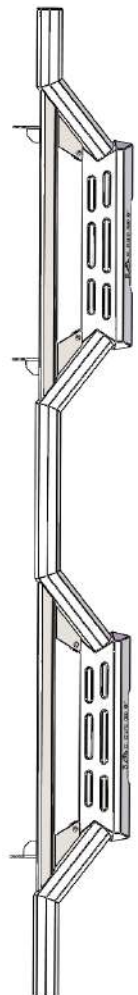

Customer Support: info@iarmorauto.com

iArmor®

Hardware Package (For Brackets & Step Bars Installation)

Item	QTY	Description	Item	QTY	Description
1#	6	Mounting Brackets	5#	12	M10X1.5-25 Hex Bolts
2#	18	M8 Plastic Washers	6#	24	M10 Flat Washers
3#	18	M8 Large Flat Washers	7#	12	M10X1.5 Nylon Lock Nuts
4#	18	M8X1.25 Nylon Lock Nuts			

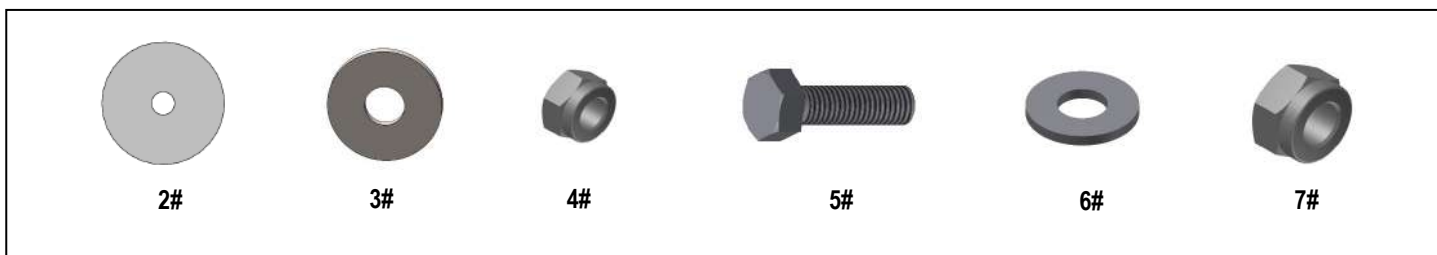

iArmor®

The instruction here is for your reference only. We strongly recommend the professional installer for best result. We are not responsible for any damage caused by the installation.

STEP 1

Start the installation from the passenger side of the vehicle. Locate the Passenger Side Mounting Locations along the inner side of the body panel, **(Fig 1)**. Use a wire brush to remove the paint or coating from all studs.

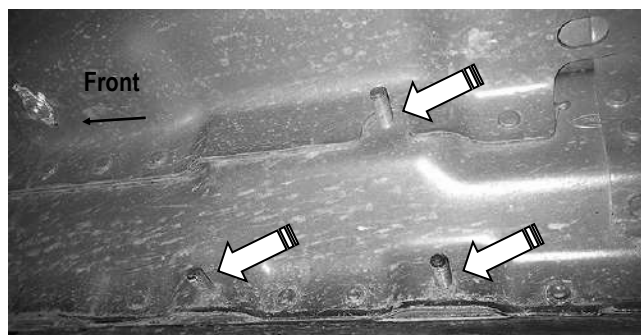

(Fig 1) Typical mounting location

STEP 2

Slide (1) M8 Plastic Washer over each of the (3) factory mounting studs on the body panel, **(Fig 2)**.

Note: The Plastic Washers are designed to prevent corrosion between the aluminum body panel and the steel mounting brackets.

STEP 3

Attach (1) Mounting Bracket to the (3) factory studs on the Passenger Side Front Mounting Location with (3) M8 Large Flat Washers and (3) M8X1.25 Nylon Lock Nuts, **(Fig 3)**. Do not fully tighten hardware at this time.

Note: All Mounting Brackets are universal.

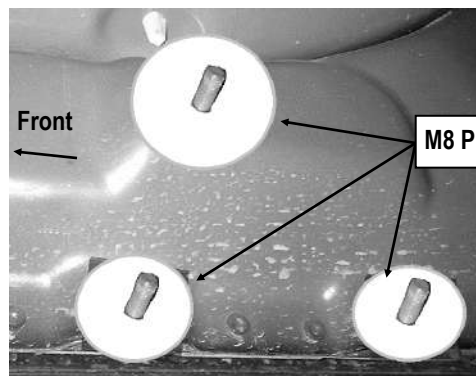

(Fig 2) Thread M8 Plastic Washers onto all mounting studs (Example On Passenger Side Front Mounting Location)

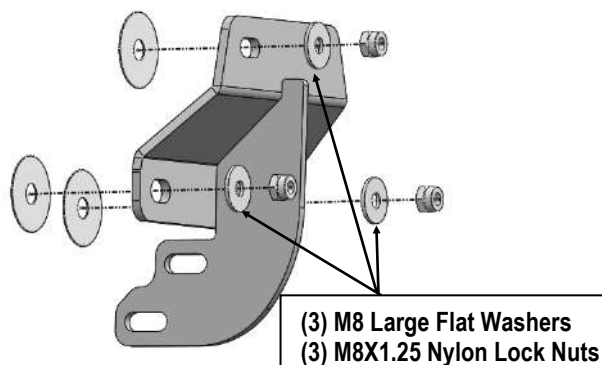

(Fig 3) Passenger Front Mounting Bracket Installation

STEP 4

Move to the Passenger Side Center and Rear Mounting Locations. Repeat **Step 3** to install the Mounting Brackets. Do not fully tighten hardware at this time.

STEP 5

Once all (3) Mounting Brackets have been installed, attach the Passenger Side Step Bar to the Mounting Brackets with (6) M10X1.5-25 Hex Bolts, (12) M10 Flat Washers and (6) M10X1.5 Nylon Lock Nuts, **(Fig 4)**. Do not fully tighten hardware at this time.

iArmor®

STEP 6

Properly level and adjust the Step Bar and fully tighten all hardware.

STEP 7

Move to the other side of the vehicle. Repeat **Steps 1—6** for other side Step Bar installation.

Attention

Do periodic inspections to the installation to make sure that all hardware is secure and tight.

In order to protect your bars/boards, please use mild soap/non-abrasive products for cleaning only.

