

iArmor®

IARMOR EDGE™

PART#: IA-N111

BEFORE INSTALLATION

REMOVE CONTENTS FROM BOX. VERIFY ALL PARTS ARE PRESENT. READ INSTRUCTIONS CAREFULLY BEFORE STARTING INSTALLATION. ASSISTANCE IS RECOMMENDED. THANK YOU FOR CHOOSING OUR PRODUCT!

***DRILLING NOT REQUIRED**

***TRIMMING NOT REQUIRED**

Torque Value

Fastener Size	Tightening Torque (ft-lbs)	Required
6mm	6-7	√
8mm	16-18	√
10mm	31-32	X
12mm	56-58	X
14mm	92-94	X



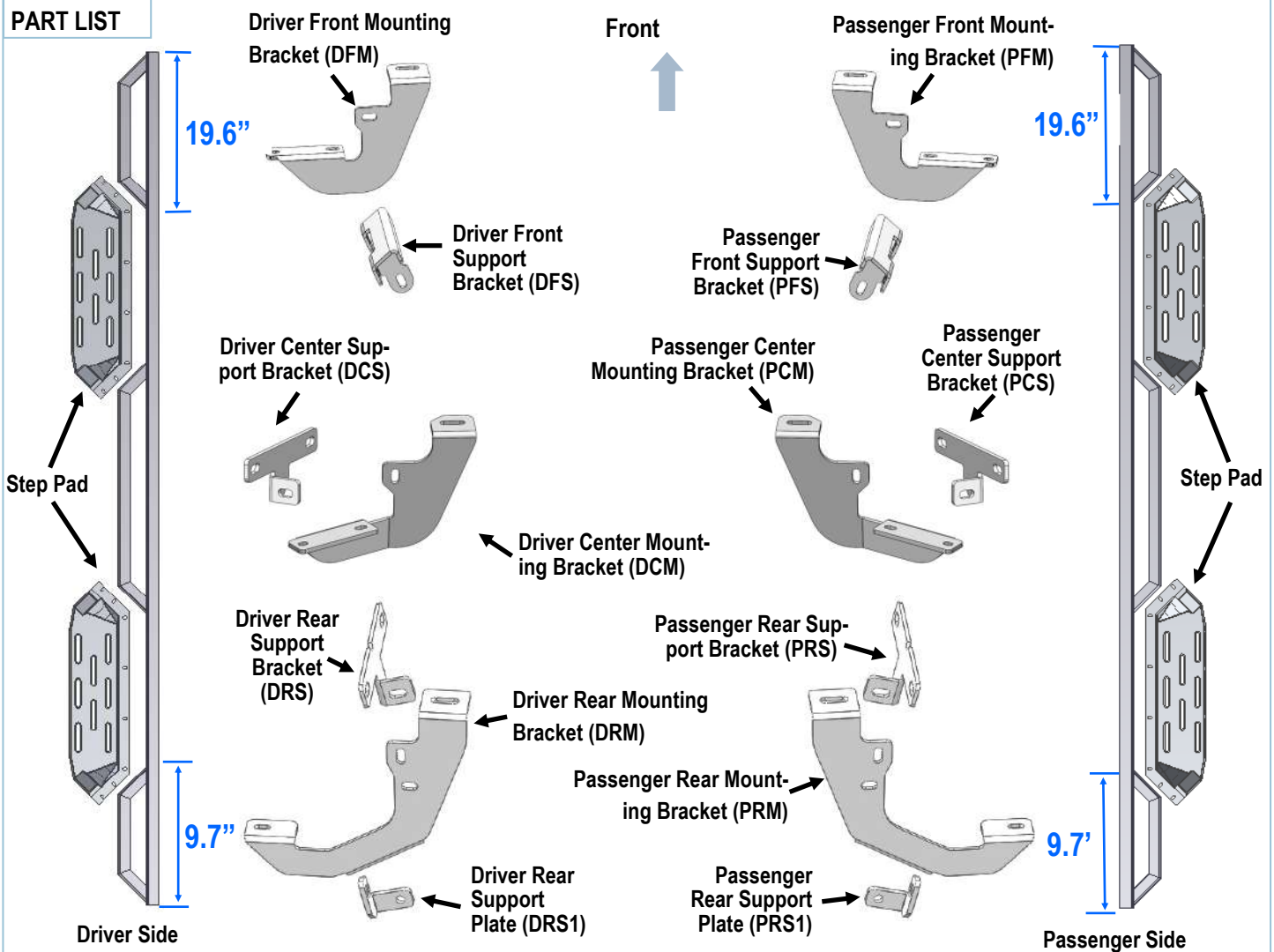







PART LIST



Customer Support: info@iarmorauto.com

iArmor[®]

Hardware Package					
Item	QTY	Description	Item	QTY	Description
1#	6	M8X1.25-35 Hex Bolts	6#	12	M6X1-25 Hex Bolts
2#	8	M8X1.25-25 Hex Bolts	7#	4	M6X1-20 Square Head Bolts
3#	22	M8 Flat Washers	8#	40	M6X1-20 T-Bolts
4#	14	M8 Lock Washers	9#	70	M6 Large Flat Washers
5#	8	M8X1.25 Hex Nuts	10#	58	M6X1 Nylon Lock Nuts

					
1#	2#	3#	4#	5#	6#
					
	7#	8#	9#	10#	

iArmor®

The instruction here is for your reference only. We strongly recommend the professional installer for best result. We are not responsible for any damage caused by the installation.

STEP 1

Install the Step Pads onto the step bars with (32) M6X1-20 T-Bolts, (32) M6 Large Flat Washers and (32) M6X1 Nylon Lock Nuts.

IMPORTANT: Don't hit the step pad by any metal hammer within step pad installation, or the step pad will be damaged.

(8) M6X1-20 T-Bolts
(8) M6 Large Flat Washers
(8) M6 Nylon Lock Nuts

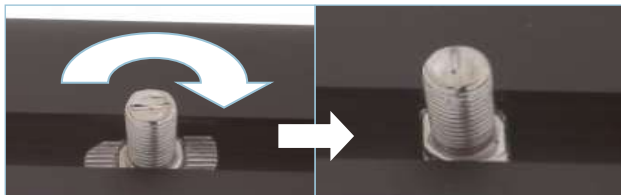
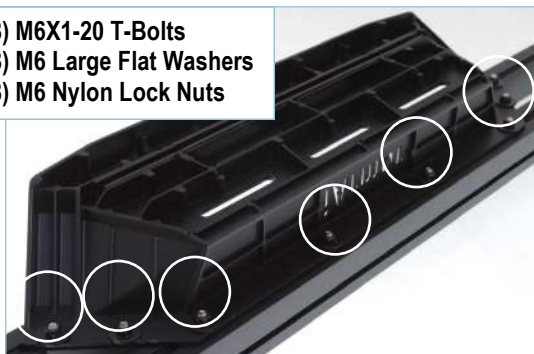

Note: Rotate 90° after inserting the T-Bolts into the Channel!!!

STEP 2

Start installation on the passenger side of the vehicle. The mounting brackets locations as shown on, (Figs 1-3). Attach brackets onto the holes on the pinch weld and the factory threaded hole on the floor panel directly behind the pinch weld.

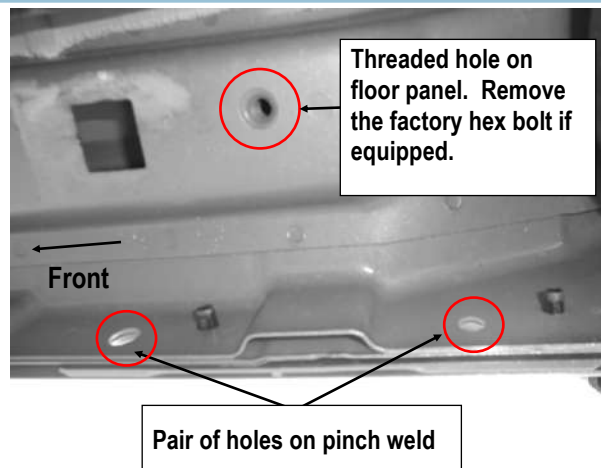

(Fig 1) Passenger Side Front Mounting Location

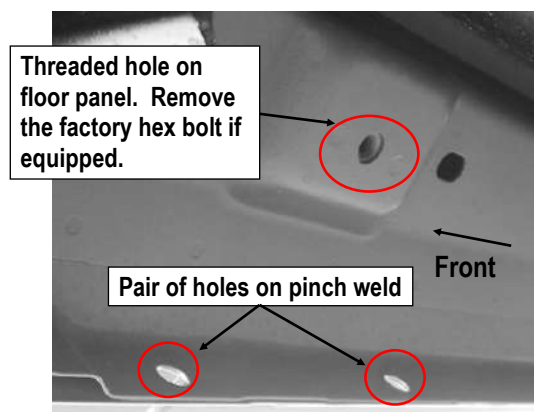

(Fig 2) Passenger Side Center Mounting Location

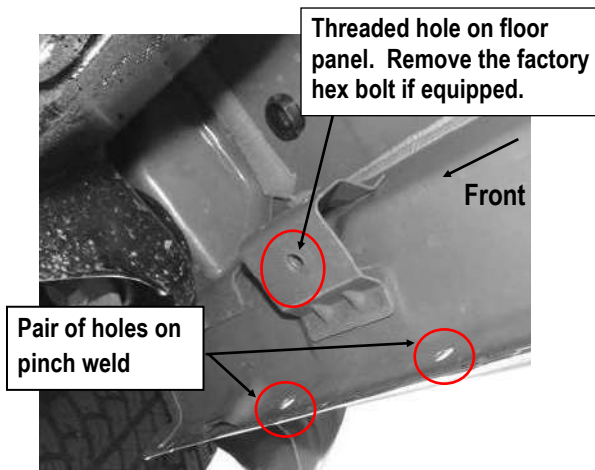

(Fig 3) Passenger Side Rear Mounting Location

iArmor®

STEP 3

Assemble the Passenger Front Mounting Bracket (PFM) and the Passenger Front Support Bracket (PFS) with (1) M8X1.25-25 Hex Bolt, (2) M8 Flat Washers, (1) M8 Lock Washer and (1) M8X1.25 Hex Nut, (Fig 4). Do not fully tighten hardware at this time.

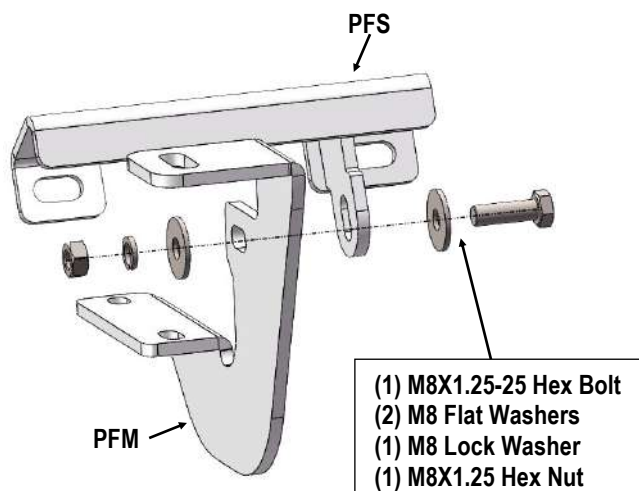

(Fig 4) Passenger Front Brackets Assembly

STEP 4

Install the Assembled Passenger Front Brackets to Passenger Side Mounting Location on the vehicle, (Fig 5). Do not fully tighten hardware at this time.

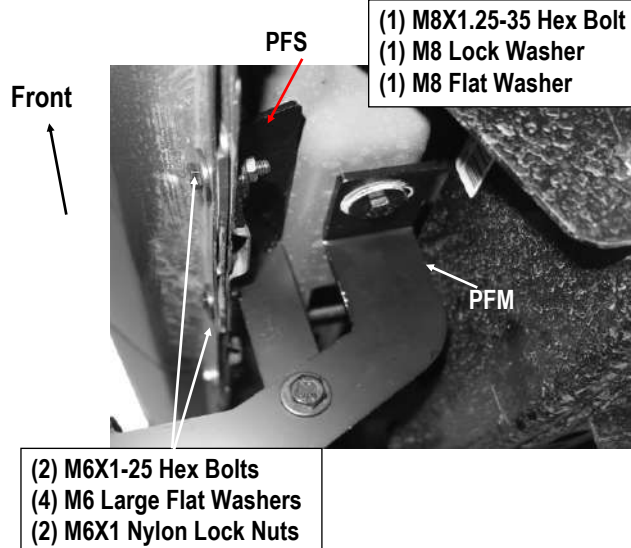

(Fig 5) Passenger Front Brackets Installed

STEP 5

Assemble the Passenger Side Center Mounting Bracket (PCM) and the Passenger Center Support Bracket (PCS), (Fig 6). Do not fully tighten hardware at this time.

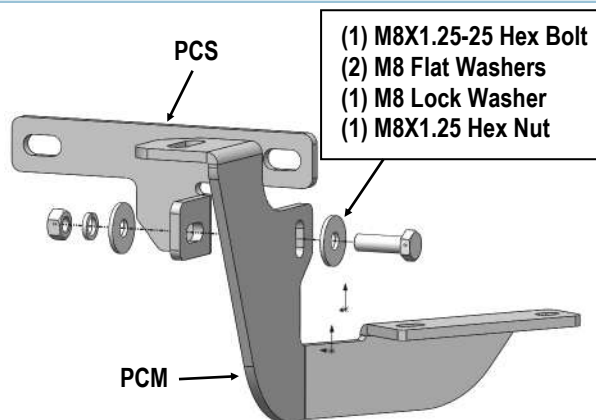

(Fig 6) Passenger Center Brackets Assembly

iArmor®

STEP 6

Install the Assembled Passenger Center Mounting Bracket on the vehicle, (Fig 7).

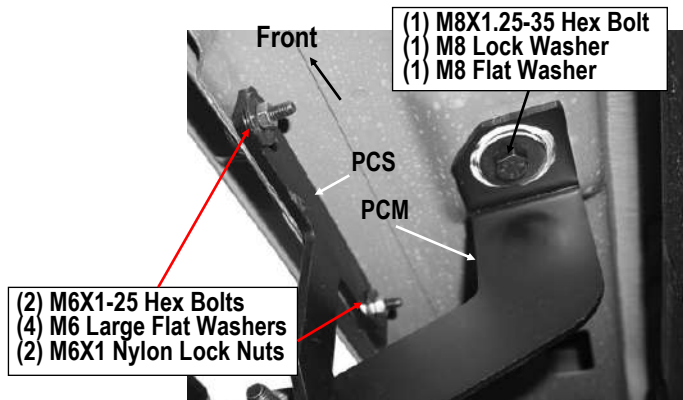

(Fig 7) Passenger Center Brackets Installed

STEP 7

Assemble the Passenger Side Rear Mounting Bracket (PRM) and the Passenger side Rear Support Bracket (PRS) and the Passenger Rear Support Plate (PRS1), (Fig 8). Do not fully tighten hardware at this time.

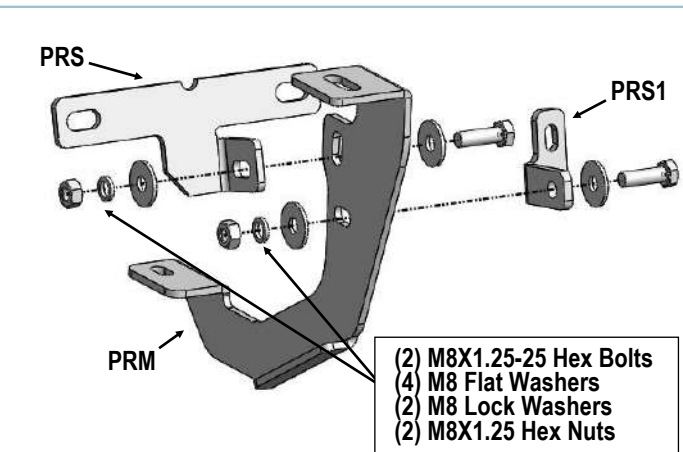

(Fig 8) Passenger Rear Brackets Assembly

STEP 8

Install the Assembled Passenger Rear Mounting Bracket on the vehicle, (Fig 9). Do not fully tighten hardware at this time.

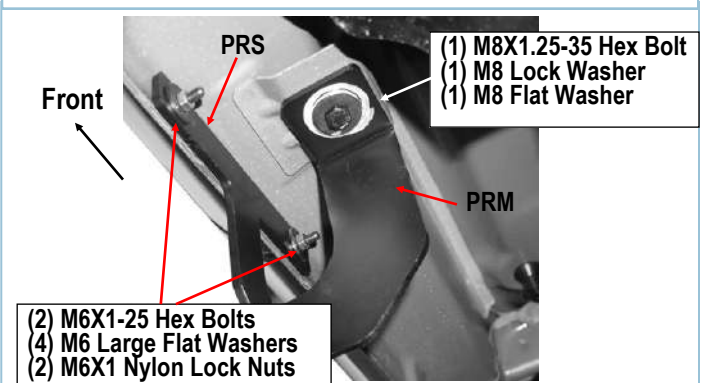

(Fig 9) Passenger Side Rear Brackets Installed

STEP 9

Once all (3) Passenger side mounting brackets are installed, attach the assembled Passenger Side Bar to the Mounting Brackets with (4) M6X1-20 T-Bolts, (2) M6X1-20 Square Head Bolt, (6) M6 Large Flat Washers and (6) M6X1 Nylon Lock Nuts, (Fig 10). Do not fully tighten hardware at this time.

STEP 10

Properly level and adjust the Step Bar and fully tighten all hardware.

Move to the driver side of the vehicle. Repeat **Steps 1-10** to install driver side step bar.

iArmor®

(Fig 10) Passenger Side Step Bar Installation

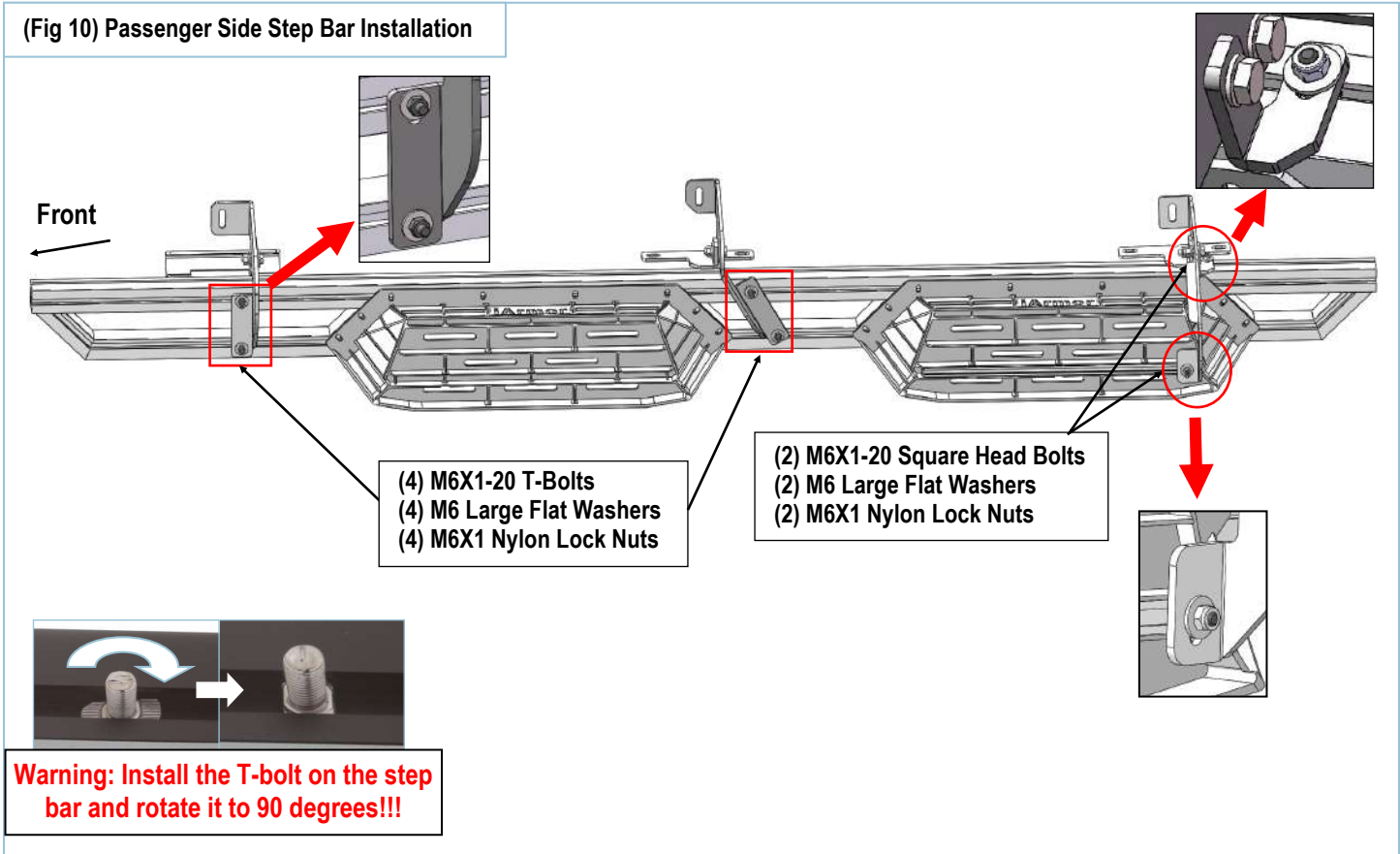

Attention

Do periodic inspections to the installation to make sure that all hardware is secure and tight. In order to protect your bars/boards, please use only mild soap/non-abrasive products for cleaning.