

# iArmor®

## IARMOR EDGE™

PART#: IA-W280

### BEFORE INSTALLATION

REMOVE CONTENTS FROM BOX. VERIFY ALL PARTS ARE PRESENT. READ INSTRUCTIONS CAREFULLY BEFORE STARTING INSTALLATION. ASSISTANCE IS RECOMMENDED. THANK YOU FOR CHOOSING OUR PRODUCT!

\*ROCKER PANEL MOUNT

\*DRILLING/TRIMMING NOT REQUIRED

### Torque Value

Fastener Size	Tightening Torque (ft-lbs)	Required
6mm	6-7	X
8mm	16-18	√
10mm	31-32	√
12mm	56-58	X
14mm	92-94	X

### PART LIST

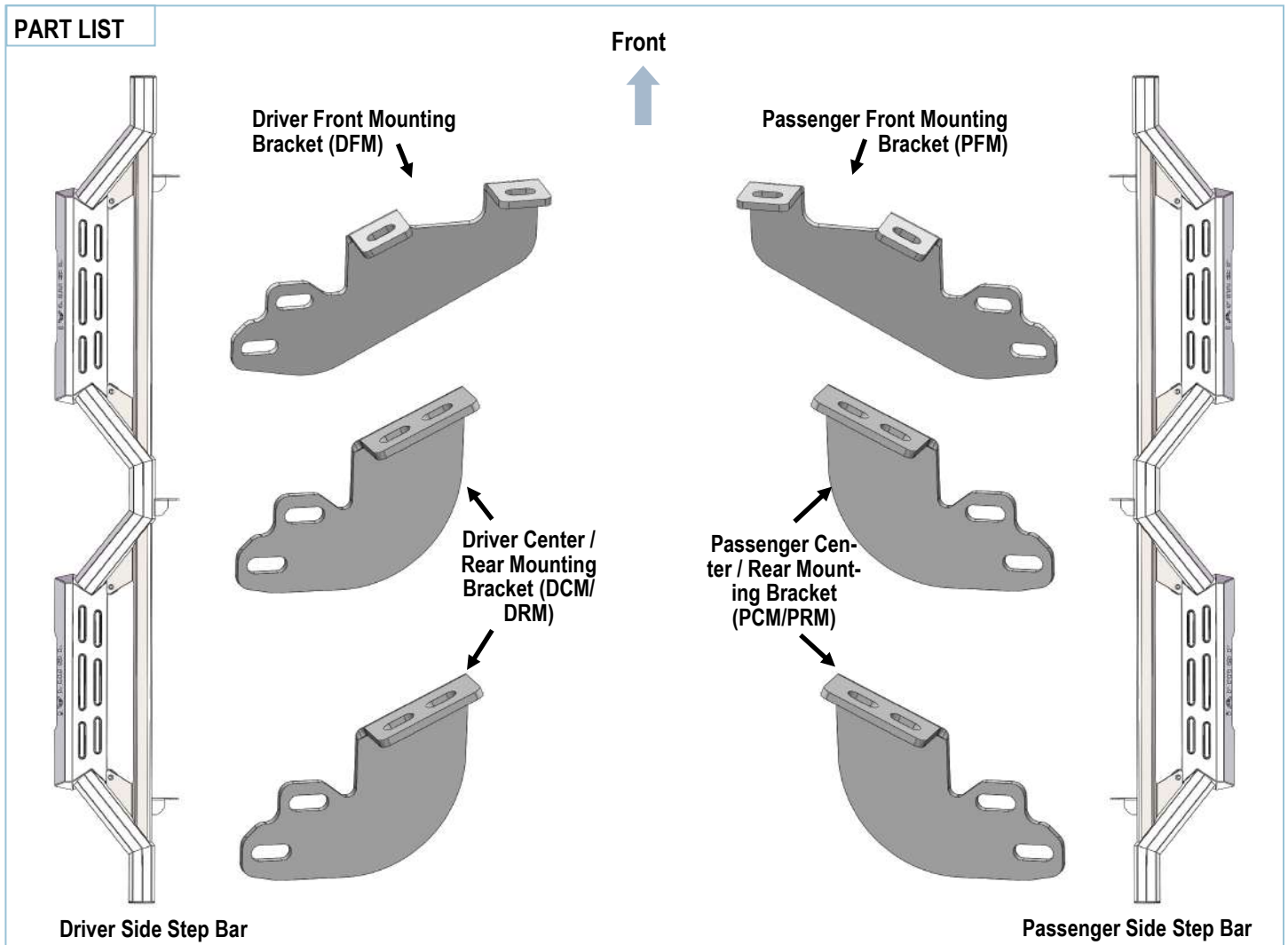

Customer Support: [info@iarmorauto.com](mailto:info@iarmorauto.com)

# iArmor®

## Hardware Package (For Brackets & Step Bars Installation)

Item	QTY	Description	Item	QTY	Description
1#	12	M8X1.25-30 Hex Bolts	4#	12	M10X1.5-25 Hex Bolts
2#	12	M8 Large Flat Washers	5#	24	M10 Flat Washers
3#	12	M8 Lock Washers	6#	12	M10X1.5 Nylon Lock Nuts

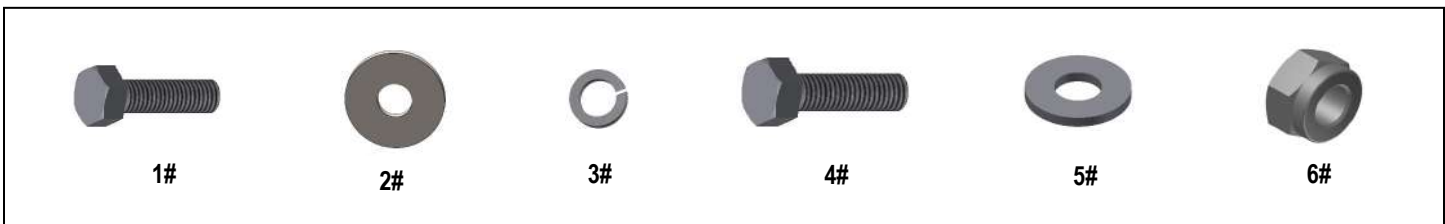

# iArmor<sup>®</sup>

The instruction here is for your reference only. We strongly recommend the professional installer for best result. We are not responsible for any damage caused by the installation.

## STEP 1

Start the installation under the passenger side of the vehicle. Remove the plastic plugs or hex bolts from the front mounting location if equipped, (Fig 1).

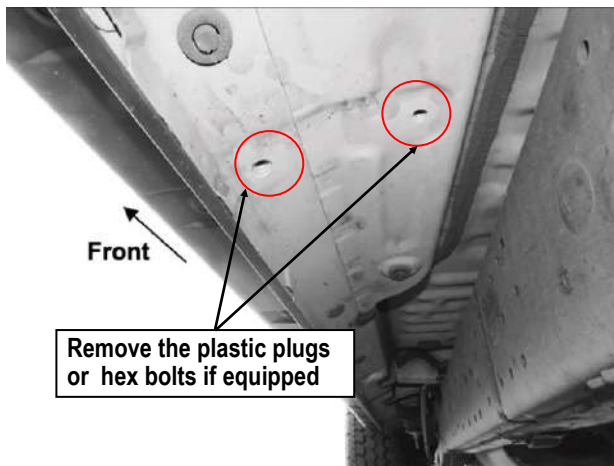

(Fig 1) Passenger Side Front Mounting Location

## STEP 2

Select the Passenger Front Mounting Bracket (PFM). Attach the Mounting Bracket to the front location with (2) M8X1.25-30mm Hex Bolts, (2) M8 Large Flat Washers and (2) M8 Lock Washers, (Fig 2). Do not fully tighten hardware at this time.

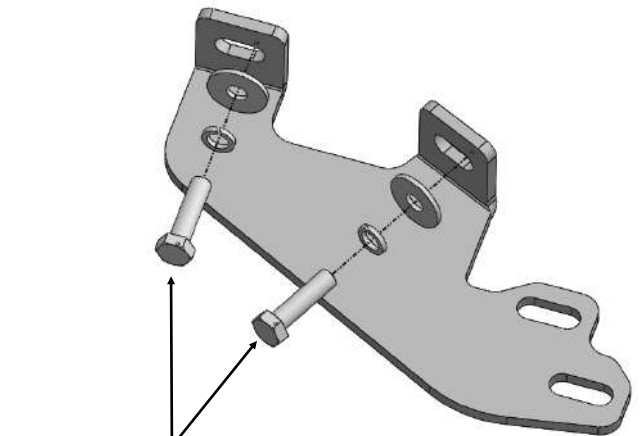

(Fig 2) Passenger Front Mounting Bracket Installation

## STEP 3

Repeat Steps 1-2 to install Passenger Center & Rear Mounting Brackets (PCM/PRM), (Figs 3-5). Do not fully tighten hardware at this time.

Note:

\*Driver Center & Rear Mounting Brackets Are Universal.

\*Passenger Center & Rear Mounting Brackets Are Universal.

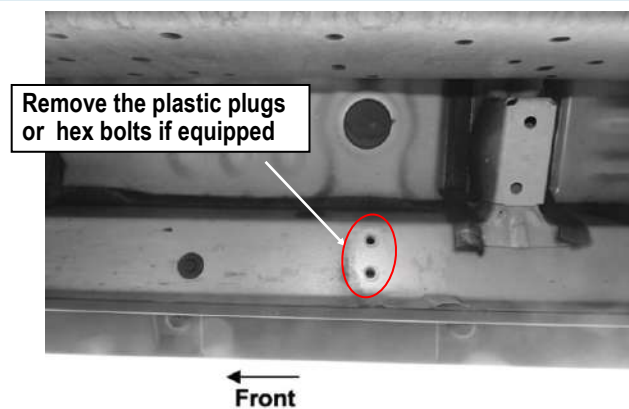

(Fig 3) Passenger Side Center Mounting Location

# iArmor®

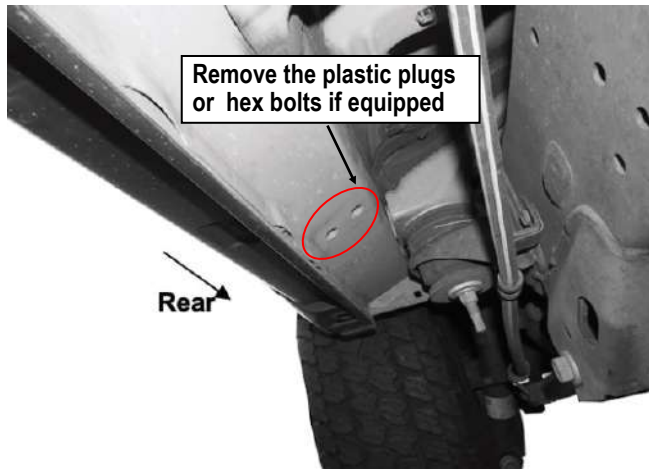

(Fig 4) Passenger Side Rear Mounting Location

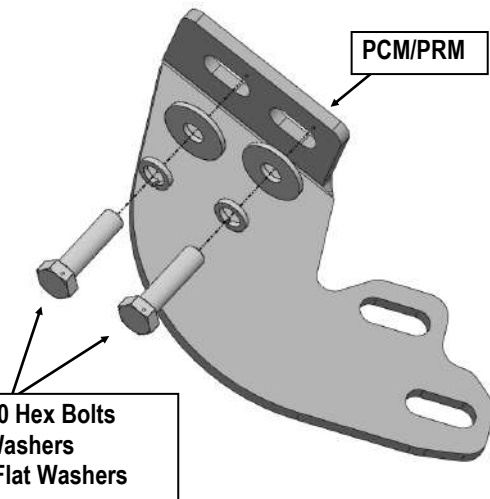

(Fig 5) Passenger Center/Rear Mounting Bracket Installation

## STEP 4

Once all (3) Mounting Brackets have been installed, attach the Passenger Side Step Bar to the Mounting Brackets with (6) M10X1.5-25 Hex Bolts, (12) M10 Flat Washers and (6) M10X1.5 Nylon Lock Nuts, (Fig 6). Do not fully tighten hardware at this time.

## STEP 5

Properly level and adjust the Step Bar and fully tighten all hardware.

## STEP 6

Move to the other side of the vehicle. Repeat **Steps 1-5** for the other Side Step Bar installation.

### Attention

Do periodic inspections to the installation to make sure that all hardware is secure and tight.

In order to protect your bars/boards, please use mild soap/non-abrasive products for cleaning only.

# iArmor<sup>®</sup>

