

iBoard®

iBoard® by APS

PART#: IB-071

READ INSTRUCTIONS CAREFULLY BEFORE STARTING INSTALLATION. REMOVE CONTENTS FROM BOX AND VERIFY ALL PARTS ARE PRESENT. ASSISTANCE IS RECOMMENDED.

*ROCKER PANEL MOUNT
*DRILLING IS REQUIRED

Fastener Size	Tightening Torque (ft-lbs)	Required
6mm	6-7	√
8mm	16-18	√
10mm	31-32	X
12mm	56-58	X
14mm	92-94	X

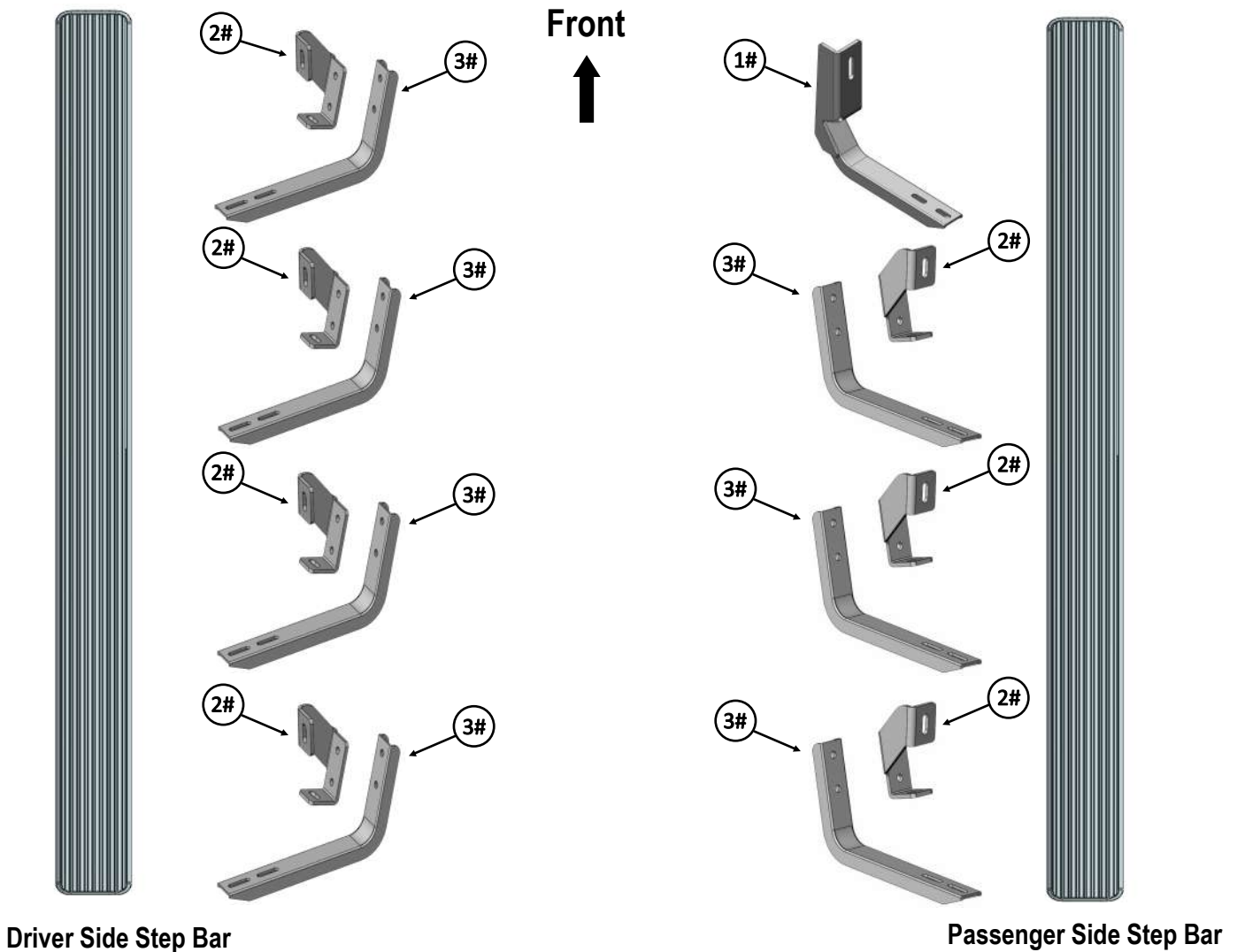



iBoard®

Mounting Bracket List					
Item	QTY	Description	Item	QTY	Description
1#	1	Passenger Front Mounting Bracket	3#	7	Mounting Brackets
2#	7	Mounting Plates			

Hardware Package A (For Bracket Installation)					
Item	QTY	Description	Item	QTY	Description
1#	1	SQ Spacer	6#	16	M8X1.25-25mm Hex Bolts
2#	14	M8X1.25-20mm Inner Hex Bolts	7#	17	M8 Large Flat Washers
3#	14	M8X1.25 Hex Flange Nuts	8#	17	M8 Lock Washers
4#	1	M8X1.25-35mm Hex Bolt	9#	15	M8 Clip Nuts
5#	1	M8X1.25 Nylon Lock Nut			

 1 #

 2 #

 3 #

 4 #

 5 #

 6 #

 7 #

 8 #

 9 #

Hardware Package B (For Aluminum Step Bar Installation Only, Not Supply to SS. Step Bar)					
Item	QTY	Description	Item	QTY	Description
1#	16	M6X1-20mm Square Head Bolts	3#	16	M6X1 Nylon Lock Nuts
2#	16	M6 Large Flat Washers			

 1 #

 2 #

 3 #

Hardware Package C (For Stainless Steel Step Bar Installation Only, Not Supply to Aluminum Step Bar)					
Item	QTY	Description	Item	QTY	Description
1#	16	M6X1-20mm Hex Bolts	3#	16	M6 Flat Washers
2#	16	M6 Lock Washers			

 1 #

 2 #

 3 #

iBoard®

STEP 1

Start the installation under the driver side of the vehicle. Locate the 4 tabs along the bottom edge of the body, (pinch weld). Mounting Brackets will bolt to the 1st, 2nd, 3rd, and 4th mounting tabs, (Fig 1). Directly above each tab is a top mounting location on the side of the body panel. Hold a Bracket up in place to help determine the mounting holes to use along the body.

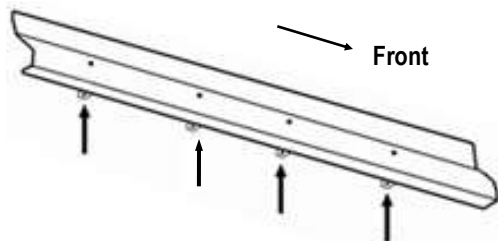

(Fig 1) Back Of Driver Side (4) Mounting Locations

STEP 2

Determine the correct procedure for your model year and each Bracket location.

Bottom mounting location on the edge of the pinch weld.

***Flat tab on pinch weld with factory installed weld nut:**

Thread M8 Hex Bolt into weld nut from the backside-down to clear paint from threads, (Fig 2).

***Flat tab on pinch weld with hole:**

Select (1) M8 Clip Nut. Slide the M8 Clip Nut over the tab with the nut facing up behind the tab, (Figs 3—5). Line up threaded nut with hole in tab. Repeat for each mounting location.

Top mounting location on the back side of the body panel.

***Models with factory installed threaded insert in body panel:**

Thread M8 Hex Bolt into threaded insert to clear paint as required, (Fig 2 & 3).

***Large and small hole in side of body panel:**

Remove the rubber plug from the larger hole, (Fig 4). Select (1) M8 Clip Nut. Slide the M8 Clip Nut into the larger hole. Line up the threaded nut with the smaller hole, (Fig 5).

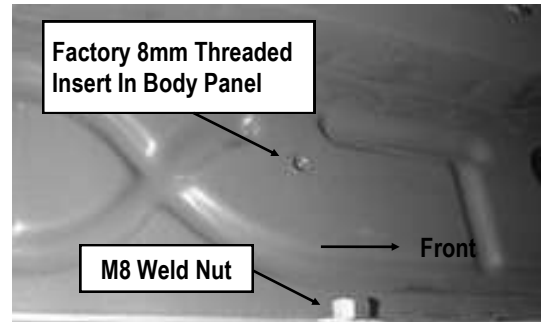

(Fig 2) Driver Front Mounting Bracket Location

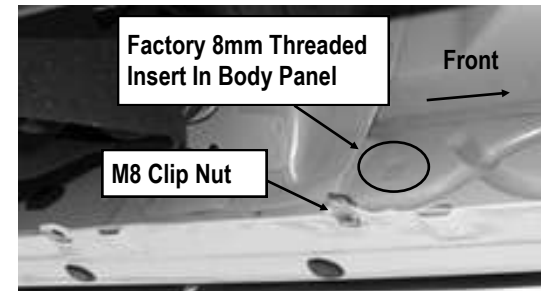

(Fig 3) Driver Center Mounting Bracket Location

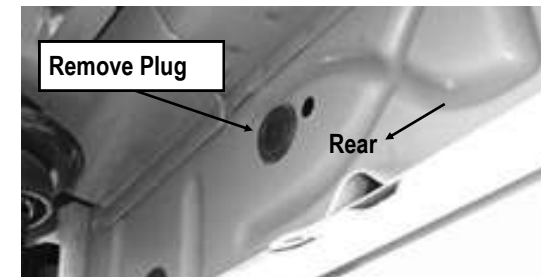

(Fig 4) Driver Rear Center Mounting Bracket Location

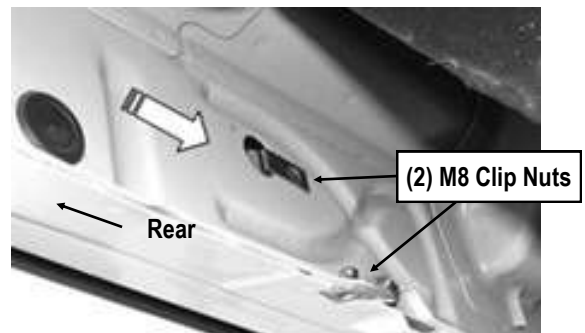

(Fig 5) Driver Rear Mounting Bracket Location

iBoard®

STEP 3

Assemble Driver Front Mounting Bracket and Driver Front Mounting Plate as shown (Fig 6). And then Bolt the Assembled Mounting Bracket to the M8 Clip Nuts and/or the factory threaded holes on Driver Side Front Mounting Location with (2) M8 x1.25-25mm Hex Bolts, (2) M8 Lock Washers and (2) M8 Large Flat Washers, (Fig 7). Snug but do not fully tighten the hardware.

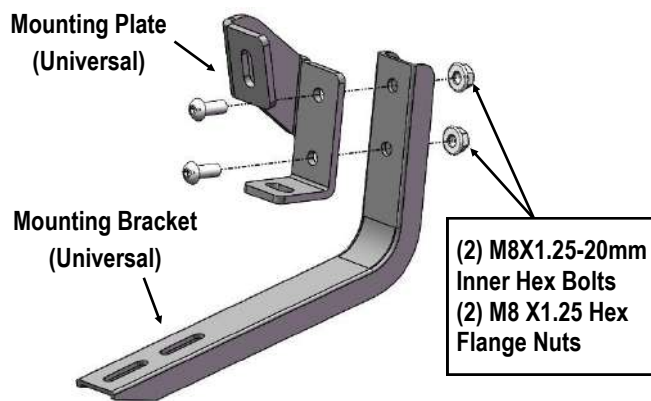

(Fig 6) Driver Front Mounting Bracket Assembled

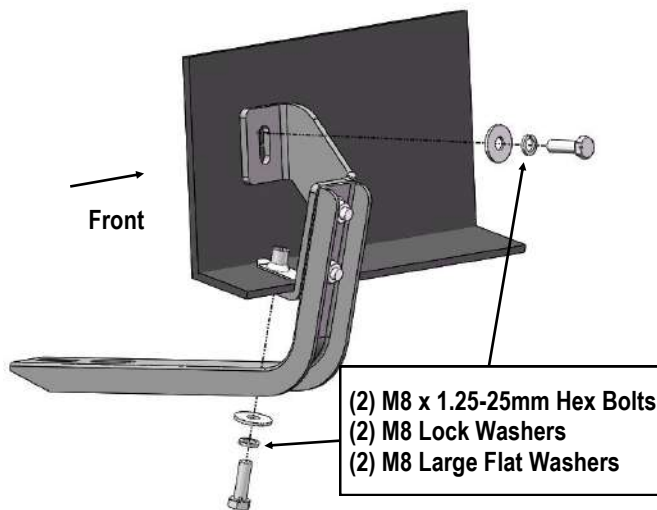

(Fig 7) Assembled Driver Front Bracket Installed

STEP 4

Repeat Steps 1—3 to install the (3) remaining driver side Brackets.

STEP 5

Once all (4) mounting brackets are installed, then proceed to the Step Bar installation. According to the style of Step Bar proceed to the correct installation STEPS.

Note: Aluminum Step Bar refer to 6; Stainless Steel Step Bar skip to STEP 7.

STEP 6

Aluminum Step Bar Installation:

Select a **Aluminum Step Bar**. Slip (4) M6x1-20mm Square Head Bolts into each bottom channel (Fig 8). Carefully position the Step Bar onto the (4) Mounting Brackets.

IMPORTANT: Do not slide the Step Bar on the Brackets or the bottom surface of the board will be damaged. Attach the Step Bar to each Mounting Brackets with (2) M6x1-20mm Square Head Bolts, (2) M6 Large Flat Washers and (2) M6X1 Nylon Lock Nuts, (Fig 9). Do not fully tighten at this time.

Level and adjust the Step Bar and fully tighten all hardware. Repeat Steps 1-6 for the other side Step Bar installation.



(Fig 8) Slip M6X1-20mm Square Head Bolts Into The Bottom Channels

(2) M6X1-20mm Square Head Bolts
(2) M6 Large Flat Washers
(2) M6X1 Nylon Lock Nuts
IMPORTANT: TORQUE FOR 6MM FASTNERS MUST LESS THAN 6-7 FT-LBS OR THE FASTNERS WILL BE DAMAGED!

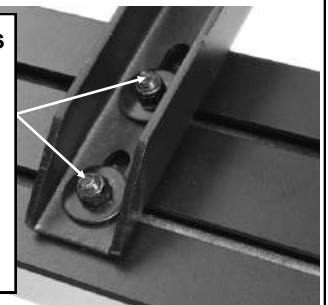

(Fig 9) Running Board Installed Onto Mounting Bracket

iBoard®

STEP 7

Stainless Steel Step Bar Installation:

Select a **Stainless Steel Step Bar** (with the U-Sliders installed on the Bar). Loosen the U-Sliders, reposition the U-Sliders onto the board according to the (4) Installed Mounting Brackets location, (Fig 10). Re-secure the U-Sliders on the Step Bar. Attach the Step Bar to the installed Mounting Brackets with (8) M6X1-20mm Hex Bolts, (8) M6 Large Flat Washers & (8) M6 Lock Washers, (Fig 11). Do not fully tighten hardware at this time. Level and adjust the Step Bar and fully tighten all hardware. Repeat **Steps 1-5 and 7** for the other side Step Bar installation.



(Fig 10) Slide & line up the U-Slider with the installed mounting brackets along bottom channel

(2) M6X1-20mm Hex Bolts
(2) M6 Large Flat Washers
(2) M6 Lock Washers
IMPORTANT: TORQUE FOR 6MM FASTNERS MUST LESS THAN 6-7 FT-LBS OR THE FASTNERS WILL BE DAMAGED!



(Fig 11) Step Bar Installed on Bracket Installed (Example)

STEP 8

Move to the passenger side of the vehicle. On the passenger side, determine if the vehicle is equipped with a plastic diesel exhaust fluid (DEF) tank, (Fig 12 & 13).

Models without DEF tank, skip to Step 9.

Models with DEF tank: The tank sits close to the side of the body. With specialized tools, the Passenger Front Mounting Bracket can be installed but room is limited. It may be easier to drop the tank down to access the inner side of the body panel for bracket installation. Tank will not need to be removed, only dropped down for access to mounting location.

IMPORTANT: If tank is full, it will be very heavy and assistance is highly recommended to avoid injury or damage to the vehicle or the tank. It is recommended that installation is performed when the DEF tank is low on fluid before dropping the tank.

- For 07-16 Models:** with plastic lower tray under the tank, remove the (3) hex bolts attaching the tray to the frame, (Fig 12), and remove the tray. **For 2017-Up 2500/3500 models:** Remove the (4) hex bolts attaching the plastic cover to DEF tank, (Fig 13A) and remove the plastic cover, (Fig 13B).
- Release the tank filler hose. Release the plug for the sending unit on the top of the tank.
- Support the tank with a floor jack. Place a smooth flat surface, (wooden block for example), between the floor jack and the tank to avoid damaging the plastic tank. Do not push up on the tank; only support the weight of the tank with the jack.
- Remove the (2) bolts securing the tank straps to the vehicle, (Fig 14). Tilt the straps to release from the brackets. Slowly lower the tank until the top of the tank is almost visible. Use blocks or stands to support the tank while installing the front Brackets.
- Proceed to **Step 9**.

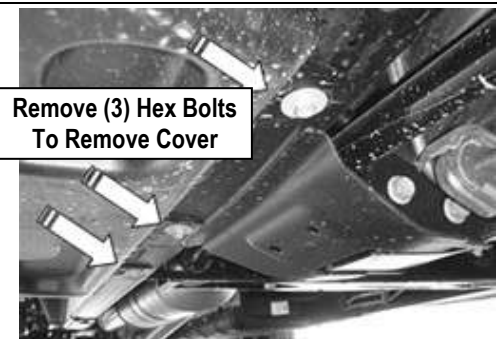

(Fig 12) 07-16 Passenger Side Front With DEF Tank Cover

iBoard®

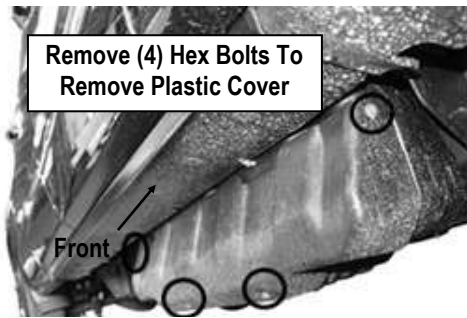

(Fig 13A) 2017-Up Passenger Side Pictured With DEF Plastic Tank Cover.



(Fig 13B) 2017 Passenger Side DEF Cover



(Fig 14) 07-16 Passenger Side DEF Tank And Cover

STEP 9

Locate the first tab on the edge of the pinch weld, attach the Passenger Front Mounting Bracket to the pinch weld and top body panel (Fig 15 & 16):

- Models with flat tab and hole:** see Fig 15. Leave loose at this time.
- Models with weld-nut:** see Fig 16. Leave loose at this time.

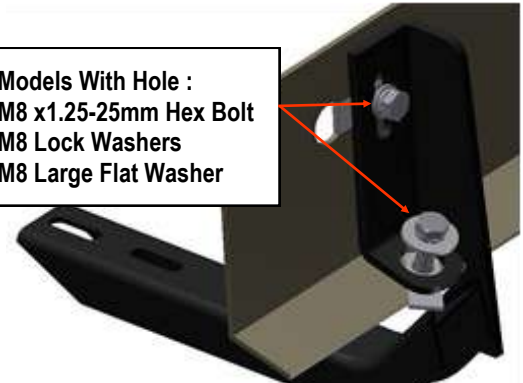

(Fig 15) Passenger Front Mounting Bracket Installed

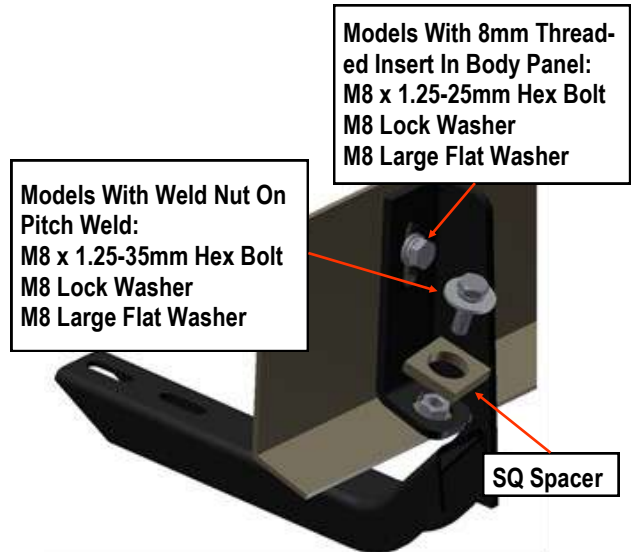

(Fig 16) Passenger Front Mounting Bracket Installed (Weld Nut If Equipped-Also See Fig 2)

STEP 10

Repeat **Steps 1—4** for the (3) remaining passenger side mounting brackets installations.

2017-up 2500/3500 DEF tank models: Locate the 2nd tab bracket location along the bottom edge of the body, (pinch weld), (Fig 17). Hold the DEF cover in place and mark the 2nd Bracket location onto the cover, (Fig 18). Use a sharp knife or hacksaw blade to carefully cut a slot in the plastic cover to clear the 2nd Bracket, (Fig 19). Remove as little plastic as possible.

iBoard®

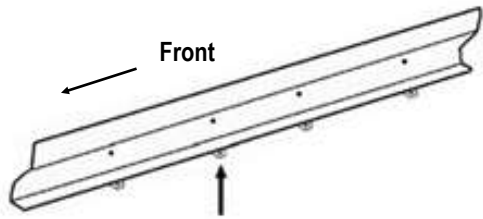

(Fig 17) Passenger 2nd Mounting Bracket Location From Back Of Body Panel

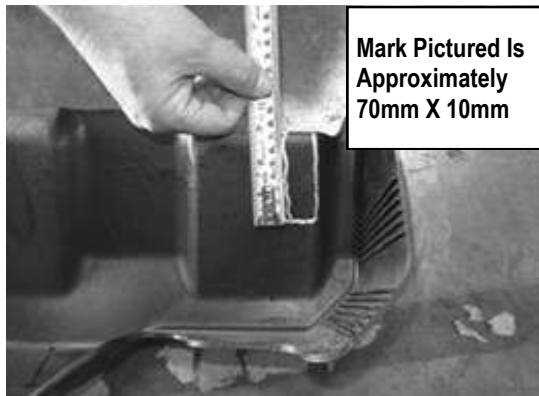

(Fig 18) 2017-Up Passenger Side DEF Cover Marked For Trimming



(Fig 19) 17-Up Passenger Side DEF Cut For Example Only

STEP 11

Repeat **Steps 5-7** to install the passenger side Running Board installation

STEP 12

Once the Running Board are installed and all hardware fully tightened, reinstall the DEF tank and cover, if equipped, as described in **Step 8**.

The installation is completed!!!

Attention

Do periodic inspections to the installation to make sure that all hardware is secure and tight.

In order to protect your bars/boards, please use only mild soap/non-abrasive products for cleaning.