

iBoard®

iBoard® by APS

PART#: IB-007

READ INSTRUCTIONS CAREFULLY BEFORE STARTING INSTALLATION. REMOVE CONTENTS FROM BOX AND VERIFY ALL PARTS ARE PRESENT. ASSISTANCE IS RECOMMENDED.

*ROCKER PANEL MOUNT
*NO DRILLING REQUIRED

Fastener Size	Tightening Torque (ft-lbs)	Required
6mm	6-7	√
8mm	16-18	X
10mm	31-32	√
12mm	56-58	X
14mm	92-94	X

PART LIST

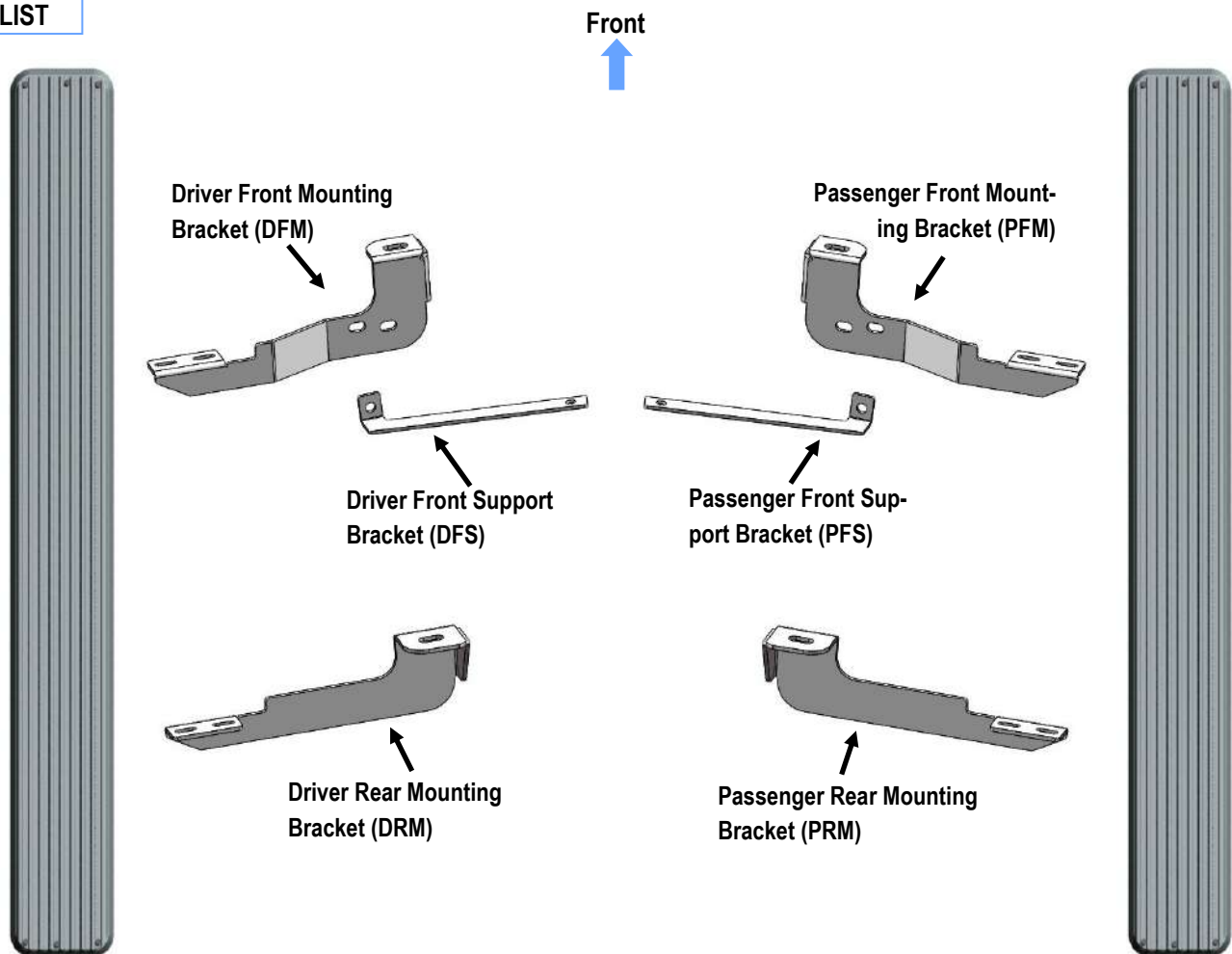

Customer Support: info@iboardauto.com

iBoard®

Hardware Package A (For Bracket Installation)

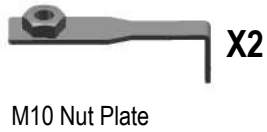

Hardware Package B (For Aluminum Step Bar Installation Only, Not Supply to Stainless Steel Step Bar)



Hardware Package C (For Stainless Steel Step Bar Installation Only, Not Supply to Aluminum Step Bar)



STEP 1

Start the installation under the Passenger side front of the vehicle. Remove the front body mount bolt, (Fig 1). Do not remove rubber bushings.

STEP 2

Attach the Passenger Front Mounting Bracket (PFM) to the body mount reusing the factory hex bolt, (Fig 2). Do not fully tighten hardware at this time.

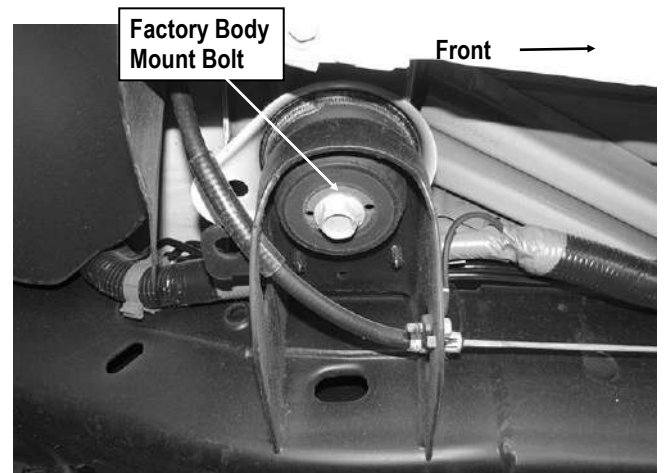

(Fig 1) Passenger Side Front Mounting Location Pictured

iBoard®

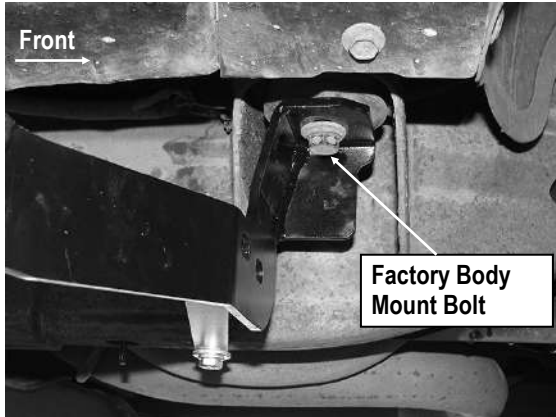

(Fig 2) Passenger Front Mounting Bracket (PFM) Installed

STEP 3

Locate the two factory holes at the bottom of the frame beside the passenger side front body mount, (Fig 3). Insert (1) M10 Nut Plate, (Fig 4), into the oval hole and line up the threaded nut with the round hole, (Fig 3). **NOTE:** Nut Plate and Support Brackets are not required on 11-14 2500/3500 models.

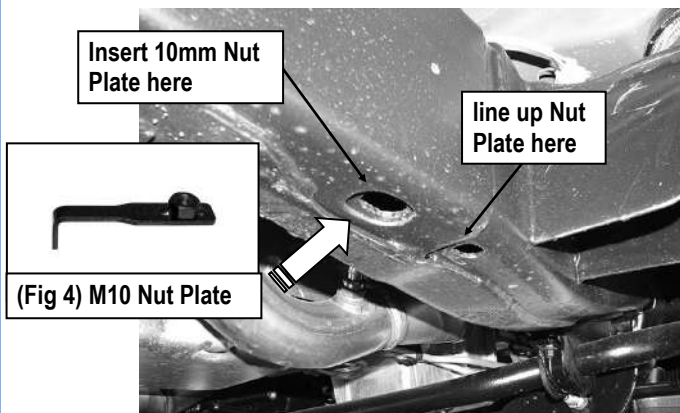

(Fig 3) Passenger Side Front Support Bracket Mounting Location

STEP 4

Attach the flat end of the Passenger Front Support Bracket (PFS) to the installed M10 Nut Plate with (1) M10X1.5-30mm Hex Bolt, (1) M10 Flat Washer and (1) M10 Lock Washer, (Fig 5 & 6). Do not fully tighten hardware at this time.

Up to 2010 2500/3500 Models:

Note that the Front Support Bracket will not reach up to the Mounting Bracket, (Fig 6). Tighten the Support Bracket to the M10 Nut Plate in the frame. Carefully push up on the Support Bracket until it reaches the inside hole in the Mounting Bracket. Bolt the Support Bracket to the hole in the Mounting Bracket with (1) M10X1.5-30mm Hex Bolt, (2) M10 Flat Washers, (1) M10 Lock Washer and (1) M10X1.5 Hex Nut, (Fig 6 & 7). Do not fully tighten hardware at this time.

NOTE: Bend Support Bracket up by hand to meet the inner hole in the Front Mounting Bracket.

Support Bracket not required on 2011-14 25-3500 Models

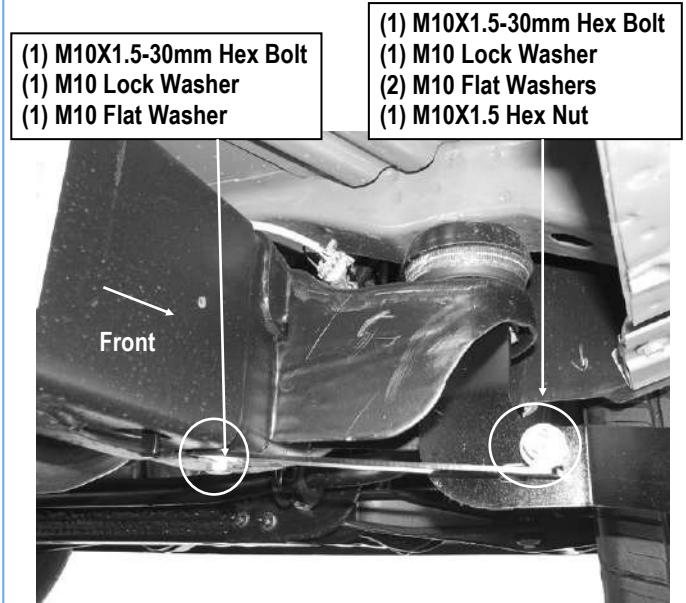

(Fig 5) Passenger Front Support Bracket (PFS) Installation (For 1500 Model)

iBoard®

- (1) M10X1.5-30mm Hex Bolt
- (1) M10 Lock Washer
- (1) M10 Flat Washers

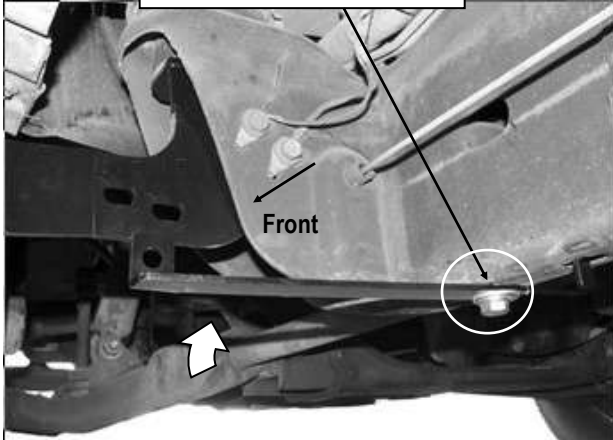

(Fig 6) Passenger Front Support Bracket Installation
(For Up to 2010 2500/3500 Models)

- (1) M10X1.5-30mm Hex Bolt
- (1) M10 Lock Washer
- (2) M10 Flat Washers
- (1) M10X1.5 Hex Nut

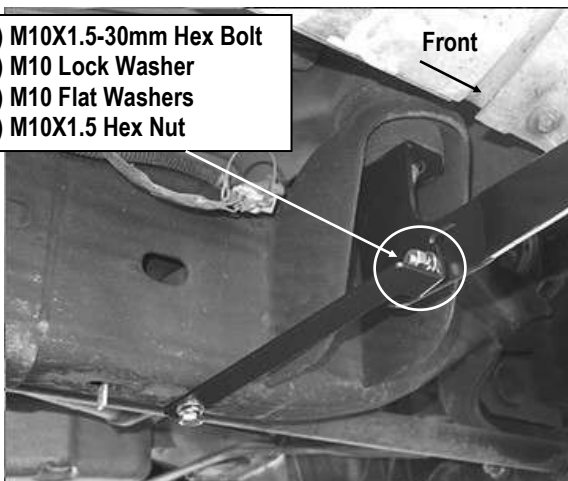

(Fig 7) Passenger Front Support Bracket Installation

STEP 5

Move to the Passenger Side Rear body mount. Repeat **Steps 1-4** to attach the Passenger Rear Mounting Bracket to the body mount, (**Fig 8**). Do not fully tighten hardware at this time.

- Factory Body Mount Bolt

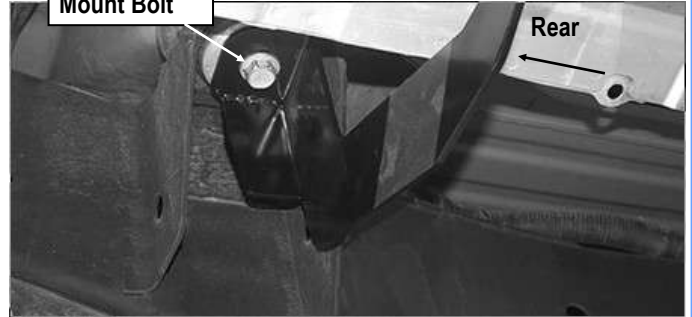

(Fig 8) Passenger Rear Mounting Bracket (PRM) Installation

STEP 6

Once all (2) mounting brackets are installed, then proceed to the Step Bar installation. According to the style of Step Bar proceed to the correct installation STEPS.

Note: Aluminum Step Bar refer to STEP 7; Stainless Steel Step Bar skip to STEP 8.

STEP 7

Aluminum Step Bar Installation:

Select a **Aluminum Step Bar**. Slip (2) M6x1-20mm Square Head Bolts into each bottom channel (**Fig 9**). Carefully position the Step Bar onto the (2) Mounting Brackets.

IMPORTANT: Do not slide the Step Bar on the Brackets or the bottom surface of the board will be damaged. Attach the Step Bar to each Mounting Brackets with (2) M6x1-20mm Square Head Bolts, (2) M6 Large Flat Washers and (2) M6X1 Nylon Lock Nuts, (**Fig 10**). Do not fully tighten at this time.

Level and adjust the Step Bar and fully tighten all hardware.

Repeat **Steps 1-7** for the other side Step Bar installation. **The installation is completed!!!**

iBoard®



(Fig 9) Slip M6X1-20mm Square Head Bolts Into The Bottom Channels



(Fig 11) Slide & line up the U-Slider with the installed mounting brackets along bottom channel

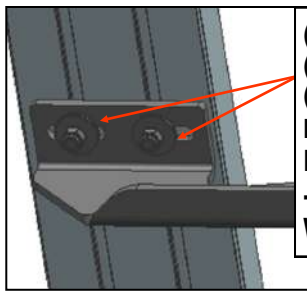

(2) M6X1-20mm Square Head Bolts
(2) M6 Large Flat Washers
(2) M6X1 Nylon Lock Nuts
IMPORTANT: TORQUE FOR 6MM FASTNERS MUST LESS THAN 6-7 FT-LBS OR THE FASTNERS WILL BE DAMAGED!

(Fig 10) Running Board Installed Onto Mounting Bracket



(2) M6X1-20mm Hex Bolts
(2) M6 Large Flat Washers
(2) M6 Lock Washers
IMPORTANT: TORQUE FOR 6MM FASTNERS MUST LESS THAN 6-7 FT-LBS OR THE FASTNERS WILL BE DAMAGED!

(Fig 12) Step Bar Installed on Bracket Installed (Example)

STEP 8

Stainless Steel Step Bar Installation:

Select a **Stainless Steel Step Bar** (with the U-Sliders installed on the Bar). Loose the U-Sliders, reposition the U-Sliders onto the board according to the (2) Installed Mounting Brackets location, (Fig 11). Re-secure the U-Sliders on the Step Bar. Attach the Step Bar to the installed Mounting Brackets with (4) M6X1-20mm Hex Bolts, (4) M6 Large Flat Washers & (4) M6 Lock Washers, (Fig 12). Do not fully tighten hardware at this time.

Level and adjust the Step Bar and fully tighten all hardware.

Repeat **Steps 1-6 and 8** for the other side Step Bar installation.
The installation is completed!!!

Attention

Do periodic inspections to the installation to make sure that all hardware is secure and tight.
In order to protect your bars/boards, please use only mild soap/non-abrasive products for cleaning.