

# iBoard®

## iBoard® by APS

PART#: IB-178

READ INSTRUCTIONS CAREFULLY BEFORE STARTING INSTALLATION. REMOVE CONTENTS FROM BOX AND VERIFY ALL PARTS ARE PRESENT. ASSISTANCE IS RECOMMENDED.

\*ROCKER PANEL MOUNT  
\*DRILLING MAY BE REQUIRED

Fastener Size	Tightening Torque (ft-lbs)	Required
6mm	6-7	√
8mm	16-18	√
10mm	31-32	X
12mm	56-58	X
14mm	92-94	X



Driver Side Step Bar

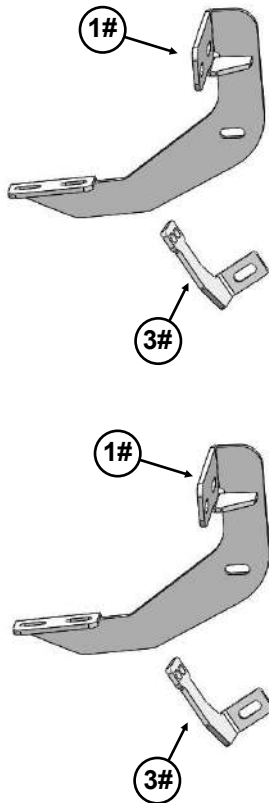

Front  
↑

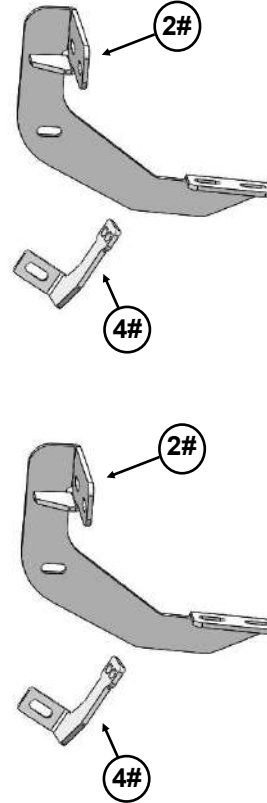

Passenger Side Step Bar

# iBoard®

Mounting Bracket List					
Item	QTY	Description	Item	QTY	Description
1#	2	Driver Front/Rear Mounting Brackets	3#	2	Driver Front/Rear Support Brackets
2#	2	Passenger Front/Rear Mounting Brackets	4#	2	Passenger Front/Rear Support Brackets

Hardware Package A (For Bracket Installation)					
Item	QTY	Description	Item	QTY	Description
1#	4	M8 Bolt/Nut Plates	6#	4	M8X1.25 Hex Nuts
2#	4	M8 Plastic Washers	7#	4	M8X1.25 Nylon Lock Nuts
3#	12	M8X1.25-30mm Hex Bolts	8#	8	M6X1-25mm Hex Bolts
4#	16	M8 Flat Washers	9#	16	M6 Large Flat Washers
5#	8	M8 Lock Washers	10#	8	M6X1 Nylon Lock Nuts

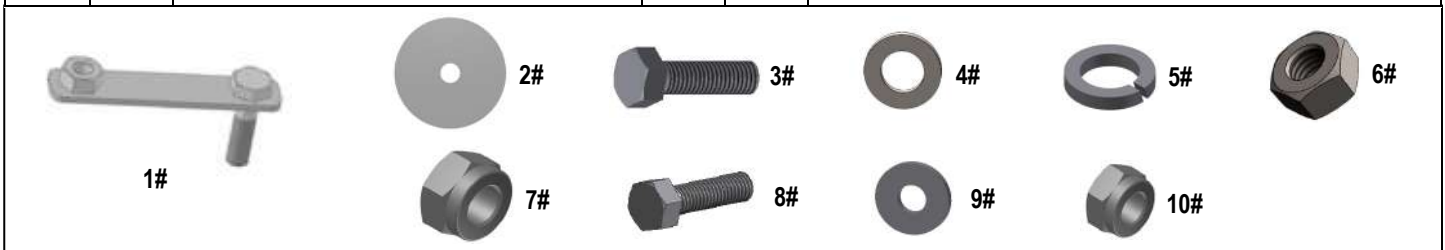

Hardware Package B (For Aluminum Step Bar Installation Only, Not Supply to SS. Step Bar)					
Item	QTY	Description	Item	QTY	Description
1#	8	M6X1-20mm Square Head Bolts	3#	8	M6X1 Nylon Lock Nuts
2#	8	M6 Large Flat Washers			



Hardware Package C (For Stainless Steel Step Bar Installation Only, Not Supply to Aluminum Step Bar)					
Item	QTY	Description	Item	QTY	Description
1#	8	M6X1-20mm Hex Bolts	3#	8	M6 Flat Washers
2#	8	M6 Lock Washers			



# iBoard®

## STEP 1

Starting at the driver side front of the vehicle, remove the sealing tape covering the factory holes in the side of the inner panel, (Fig 1).

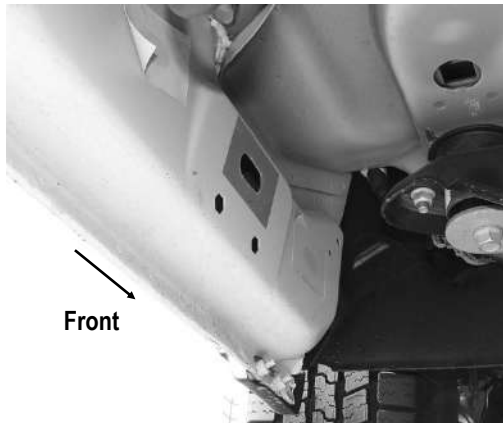

(Fig 1) 2009-Mid 2015 Driver Side Front Mounting Location  
(No Factory Holes In Pinch Weld on Some Models)

## STEP 2

Determine the correct procedure to attach the Driver Front Mounting Bracket for your model/year:

### Models without factory threaded inserts in body panel:

- a. Select (1) M8 Bolt/Nut Plate (Fig 2). Partially thread (1) M8X1.25-30mm Hex Bolt in the Welded nut on the Bolt/Nut Plate until it is flush with the welded nut, (Fig 3). Use the Hex Bolt as a handle and insert the Bolt/Nut Plate into the oval hole, (Fig 4). Feed the threaded bolt on the Bolt Plate through one of the hex factory holes. Thread (1) M8 Plastic Washer onto the welded bolt and down tight against the body panel, (Fig 5).

**NOTE:** The Plastic Washer is designed to keep the Bolt/Nut Plate out of falling into the body panel and to aid in Bracket installation.

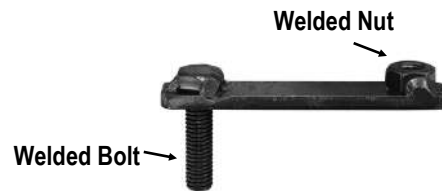

(Fig 2) M8 Bolt/Nut Plate (NOTE: M8 Bolt/Nut Plate Is Not Required On Models With Factory Threaded Inserts)

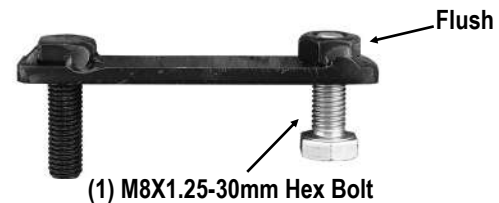

(Fig 3) Thread (1) M8 Hex Bolt Into The Nut On The Plate. Stop When Bolt Reaches End Of Nut As Pictured

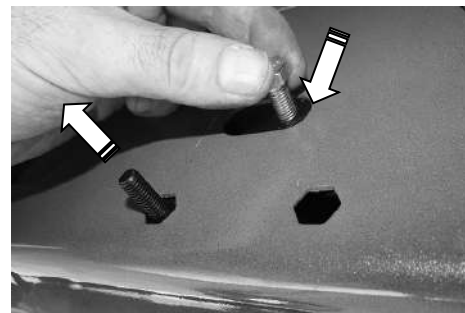

(Fig 4) Use The Loose Hex Bolt As A Handle. Insert The M8 Bolt/Nut Plate Into The Oval Hole And Feed The Welded Bolt End Out Either Factory Hex Hole on Body Panel.



(Fig 5) Thread Plastic Washer Onto the Welded Bolt on M8 Bolt/Nut Plate To Hold Bolt/Nut Plate In Position.  
**IMPORTANT:** Do Not Remove The Hex Bolt Until The M8 Plastic Washer Has Been Threaded Onto the Welded Bolt.

# iBoard®

b. Select (1) Driver Front Mounting Bracket. Attach the mounting bracket to the welded bolt end of the M8 Bolt/Nut Plate with (1) M8 Large Flat Washer, (1) M8 Lock Washer and (1) M8X1.25 Hex Nut, (Fig 6A). Do not fully tighten at this time.

Hold the welded bolt on the M8 Bolt/Nut Plate and rotate the Bolt/Nut Plate until the welded nut lines up with the remaining hex hole on the body panel.

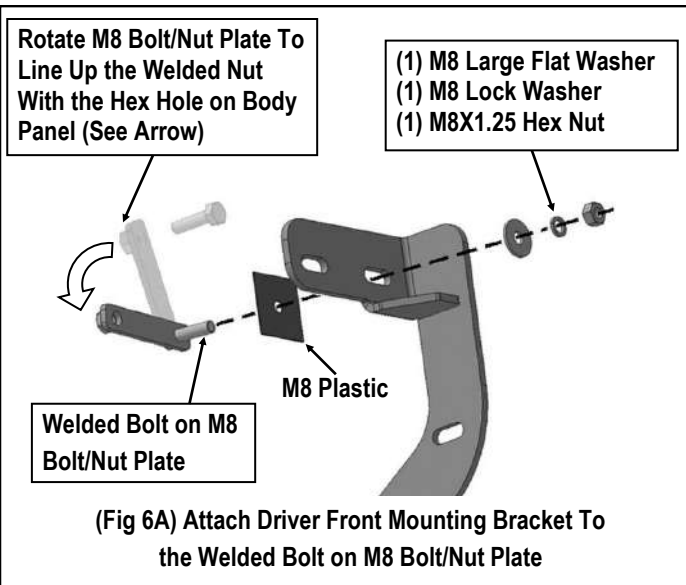

c. Secure the Driver Front Mounting Bracket to the welded nut on the M8 Bolt/Nut Plate with (1) M8x1.25- 30mm Hex Bolt, (1) M8 Lock Washer and (1) M8 Large Flat Washer (Fig 6B). Do not fully tighten hardware at this time.

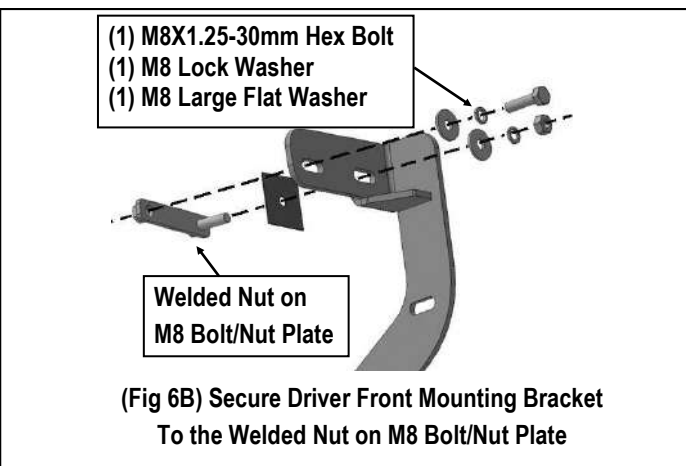

## Models with factory threaded inserts:

Attach Driver Front Mounting Bracket to the threaded inserts with (2) M8x1.25-30mm Hex Bolts, (2) M8 Lock Washers and (2) M8 Large Flat Washers, (Fig 7 & 8). Leave hardware loose.

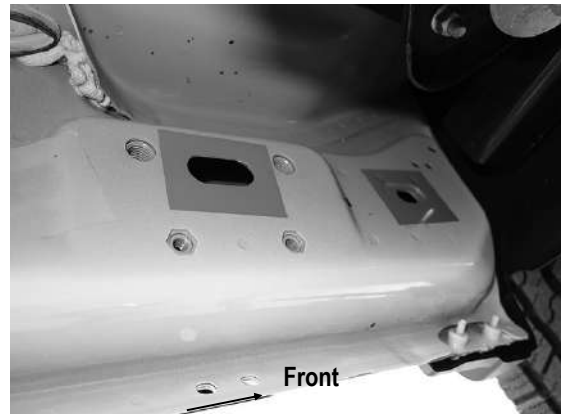

(Fig 7) Driver Side Front Mounting Location (Mid 2015-On, An Example Of Models With Factory Threaded Inserts)

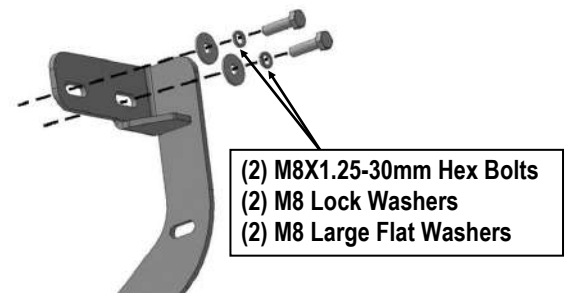

# iBoard®

## STEP 3

Attach the Driver Front Support Bracket to the Driver Front Mounting Bracket with (1) M8X1.25-30mm Hex Bolt, (2) M8 Large Flat Washers and (1) M8X1.25 Nylon Lock Nut, (Fig 9). Rotate the support bracket to attach the back side of the pinch weld. Line up the slots in the top of the Support Bracket with the (2) factory holes in the pinch weld. Attach the support bracket to the back of the pinch weld with (2) M6x1-25mm Hex Bolts, (4) M6 Large Flat Washers and (2) M6X1 Nylon Lock Nuts, (Fig 10A & 10B). Do not fully tighten hardware at this time. **IMPORTANT: Some models are not equipped with factory holes and will require drilling through the pinch weld to attach the Support Bracket. Do not drill through pinch weld at this time, (Refer to Step 8).**

- (1) M8X1.25-30mm Hex Bolt
- (2) M8 Large Flat Washers
- (1) M8X1.25 Nylon Lock Nut

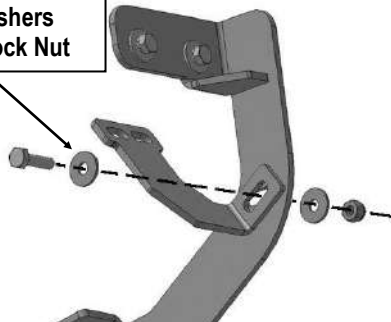

(Fig 9) Attach Driver Front Support Bracket To Front Facing Side Of the Driver Front Mounting Bracket

- (2) M6X1-25mm Hex Bolts
- (4) M6 Large Flat Washers
- (2) M6X1 Nylon Lock Nuts



(Fig 10A) Attach Driver Front Support Bracket To the Back Of Pinch Weld (Models With Factory Holes In Pinch Weld Only)

**IMPORTANT: Models w/o holes in pinch weld will require drilling 1/4" holes through pinch weld to attach Support Brackets. Do complete installation of Step Bar first and level Step Bar before drilling holes for Support Brackets (refer to Step 6).**



(Fig 10B) Driver Front Brackets installed

## STEP 4

Move along the side of the body panel to the Driver Side Rear Mounting Location, (Figs 11). Repeat Steps 2-3 to install the driver side rear brackets, (Fig 12).



(Fig 11) Driver Side Rear Mounting Location

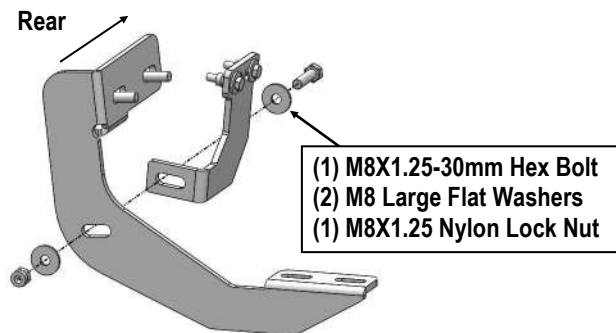

(Fig 12) Driver Rear Brackets Installed

# iBoard®

## STEP 5

Once all (2) mounting brackets are installed, then proceed to the Step Bar installation. According to the style of Step Bar proceed to the correct installation STEPS.

**Note:** Aluminum Step Bar refer to STEP 6; Stainless Steel Step Bar skip to STEP 7.

## STEP 6

### **Aluminum Step Bar Installation:**

Select a **Aluminum Step Bar**. Slip (2) M6x1-20mm Square Head Bolts into each bottom channel (**Fig 13**). Carefully position the Step Bar onto the (2) Mounting Brackets.

**IMPORTANT:** Do not slide the Step Bar on the Brackets or the bottom surface of the board will be damaged. Attach the Step Bar to each Mounting Brackets with (2) M6x1-20mm Square Head Bolts, (2) M6 Large Flat Washers and (2) M6x1 Nylon Lock Nuts, (**Fig 14**). Do not fully tighten at this time.

Level and adjust the Step Bar and fully tighten all hardware. Repeat **Steps 1-6** for the other side Step Bar installation.



(Fig 13) Slip M6X1-20mm Square Head Bolts Into The Bottom Channels

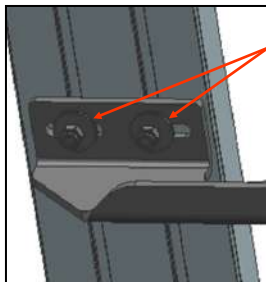

(2) M6X1-20mm Square Head Bolts  
(2) M6 Large Flat Washers  
(2) M6X1 Nylon Lock Nuts  
**IMPORTANT: TORQUE FOR 6MM FASTNERS MUST LESS THAN 6-7 FT-LBS OR THE FASTNERS WILL BE DAMAGED!**

(Fig 14) Step Bar Installed Onto Mounting Bracket

## STEP 7

### **Stainless Steel Step Bar Installation:**

Select a **Stainless Steel Step Bar** (with the U-Sliders installed on the Bar). Loose the U-Sliders, reposition the U-Sliders onto the board according to the (2) Installed Mounting Brackets location, (**Fig 15**). Re-secure the U-Sliders on the Step Bar. Attach the Step Bar to the installed Mounting Brackets with (4) M6X1-20mm Hex Bolts, (4) M6 Large Flat Washers & (4) M6 Lock Washers, (**Fig 16**). Do not fully tighten hardware at this time. Level and adjust the Step Bar and fully tighten all hardware. Repeat **Steps 1-5 and 7** for the other side Step Bar installation.



(Fig 15) Slide & line up the U-Slider with the installed mounting brackets along bottom channel

(2) M6X1-20mm Hex Bolts  
(2) M6 Large Flat Washers  
(2) M6 Lock Washers  
**IMPORTANT: TORQUE FOR 6MM FASTNERS MUST LESS THAN 6-7 FT-LBS OR THE FASTNERS WILL BE DAMAGED!**

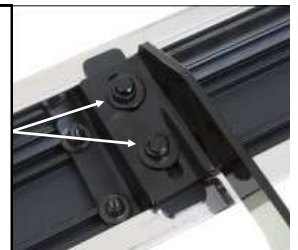

(Fig 16) Step Bar Installed on Bracket Installed

# iBoard®

## STEP 8

Properly level and adjust the Step Bar and fully tighten all hardware.

### Models required drilling on Pinch Weld for driver side Support Brackets:

- a. Make sure the Step Bar is level to the vehicle. Adjust and tighten all mounting hardware.
- b. Line up the slots on the Support Brackets with the back of the pinch weld. Mark the location of the slots onto the pinch weld.
- c. Drill (2) 1/4" holes through the pinch weld for each Support Bracket.  
**IMPORTANT:** Do not drill too close to the bottom edge of the pinch weld. Adjust the Brackets as necessary to move the slots up the body panel away from the edge. Drill the holes toward the outside of the marked slots.
- d. Attach each Support Brackets to the pinch weld with (2) M6X1-25mm Hex Bolts, (4) M6 Large Flat Washers and (2) M6X1 Nylon Lock Nuts, (**Fig 10 & 12**). Check for level then fully tighten all hardware.

## STEP 9

Repeat **Steps 1-8** for the other side Running Board installation.  
**The installation is completed.**

### Attention

**Do periodic inspections to the installation to make sure that all hardware is secure and tight.**

**In order to protect your bars/boards, please use only mild soap/non-abrasive products for cleaning.**