

iBoard®

iBoard® by APS

PART#: IB-002

READ INSTRUCTIONS CAREFULLY BEFORE STARTING INSTALLATION. REMOVE CONTENTS FROM BOX AND VERIFY ALL PARTS ARE PRESENT. ASSISTANCE IS RECOMMENDED.

*ROCKER PANEL MOUNT
*DRILLING IS REQUIRED

Fastener Size	Tightening Torque (ft-lbs)	Required
6mm	6-7	√
8mm	16-18	√
10mm	31-32	√
12mm	56-58	X
14mm	92-94	X

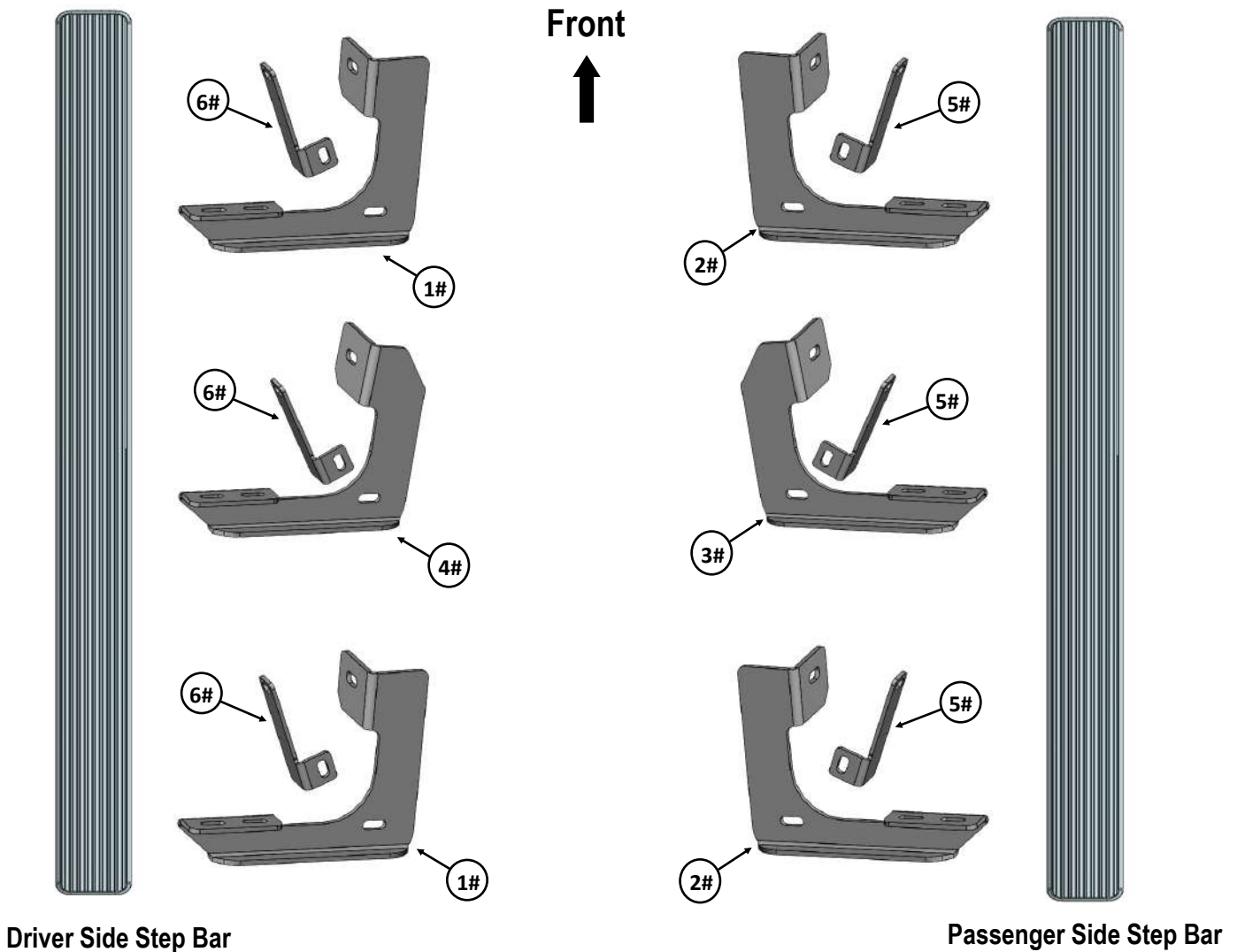

iBoard®

Mounting Bracket List					
Item	QTY	Description	Item	QTY	Description
1#	2	Driver Front / Rear Mounting Brackets	4#	1	Driver Center Mounting Bracket
2#	2	Passenger Front / Rear Mounting Brackets	5#	3	Passenger Support Brackets
3#	1	Passenger Center Mounting Bracket	6#	3	Driver Support Brackets

Hardware Package A (For Bracket Installation)					
Item	QTY	Description	Item	QTY	Description
1#	6	M10X40 Bolt Plates	6#	12	M8X1.25-25mm Hex Bolts
2#	6	M10 Plastic Washers	7#	12	M8 Large Flat Washers
3#	6	M10 Large Flat Washers	8#	12	M8 Flat Washers
4#	6	M10 Lock Washers	9#	12	M8X1.25 Nylon Lock Nuts
5#	6	M10X1.5 Hex Nuts			



1#



2#



3#



4#



5#



6#



7#



8#



9#

Hardware Package B (For Aluminum Step Bar Installation Only, Not Supply to SS. Step Bar)					
Item	QTY	Description	Item	QTY	Description
1#	12	M6X1-20mm Square Head Bolts	3#	12	M6X1 Nylon Lock Nuts
2#	12	M6 Large Flat Washers			



1#



2#



3#

Hardware Package C (For Stainless Steel Step Bar Installation Only, Not Supply to Aluminum Step Bar)					
Item	QTY	Description	Item	QTY	Description
1#	12	M6X1-20mm Hex Bolts	3#	12	M6 Flat Washers
2#	12	M6 Lock Washers			



1#



2#



3#

iBoard®

STEP 1

Starting toward the front of the driver side, locate the (2) oval holes in the inner body panel. Remove the tape covering the second factory hole, (Fig 1). Thread (1) M10 Plastic Washer onto (1) M10X35 Bolt Plate. Insert the M10X35 Bolt Plate into the factory hole on the rocker panel. Hold the M10X35 Bolt Plate in place with one hand and continue to thread the M10 Plastic Washer down against the sheet metal until it holds the M10X35 Bolt Plate in place, (Fig 2).

IMPORTANT: The Plastic Washer is designed to prevent the Bolt Plate from falling into the body panel and to aid Bracket installation.



(Fig 1) Driver Front Mounting Bracket Location

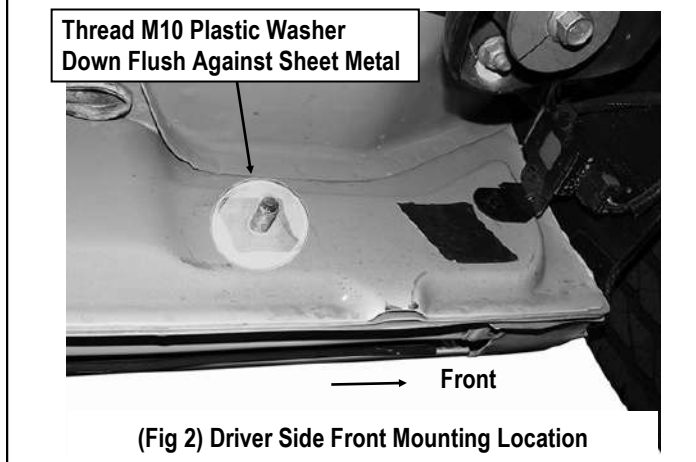

(Fig 2) Driver Side Front Mounting Location

STEP 2

Select and assemble (1) Driver Front Mounting Bracket and (1) Driver Support Bracket with (1) M8x1.25-25mm Hex Bolt, (2) M8 Large Flat Washers and (1) M8 x1.25 Nylon Lock Nut, (Fig 3). Do not fully tighten hardware at this time.

NOTE: Place the flat end of the Support Bracket up against the pinch weld at the bottom of the body panel.

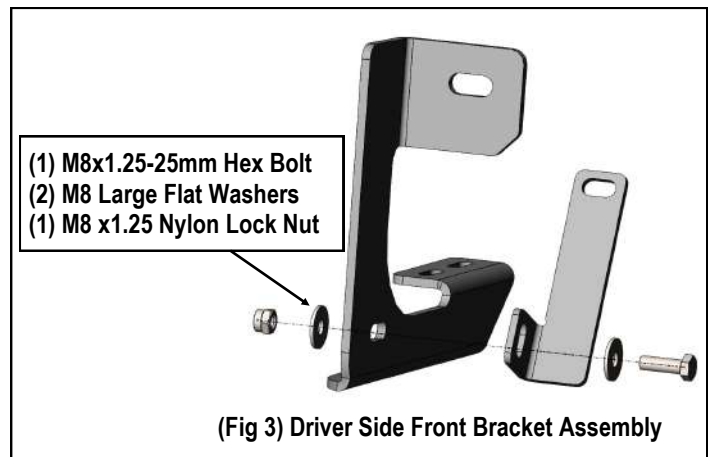

(Fig 3) Driver Side Front Bracket Assembly

STEP 3

Attach the Assembled Driver Front Mounting Bracket to the M10X35 Bolt Plate with (1) M10 Large Flat Washer, (1) M10 Lock Washer and (1) M10x1.5 Hex Nut, (Fig 4). Do not fully tighten hardware at this time.

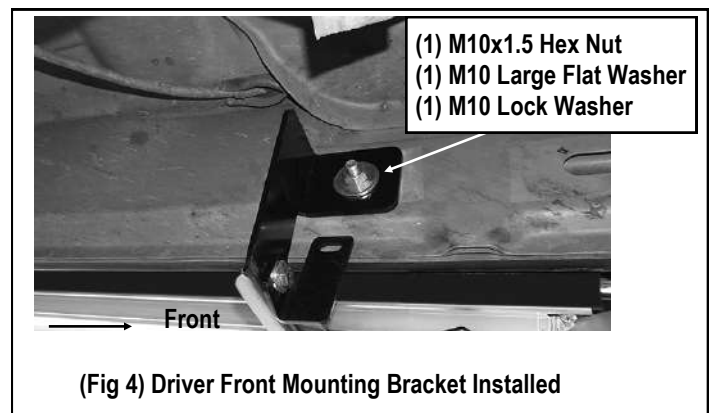

(Fig 4) Driver Front Mounting Bracket Installed

iBoard®

STEP 4

Next, move to the driver center & rear mounting location, (Fig 5 & 6). Repeat **Steps 1-3** to install the Driver Center & Rear Mounting Brackets, (Fig 7 & 8). Do not fully tighten hardware at this time.

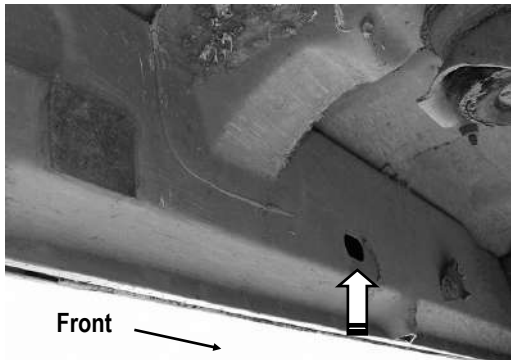

(Fig 5) Driver Center Mounting Bracket Location

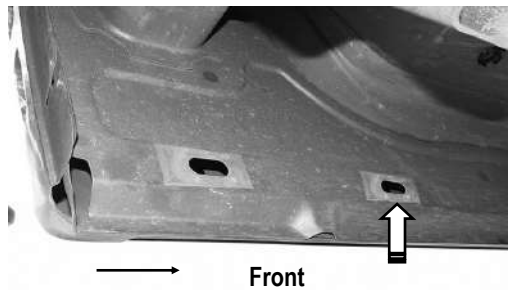

(Fig 6) Driver Rear Mounting Bracket Location

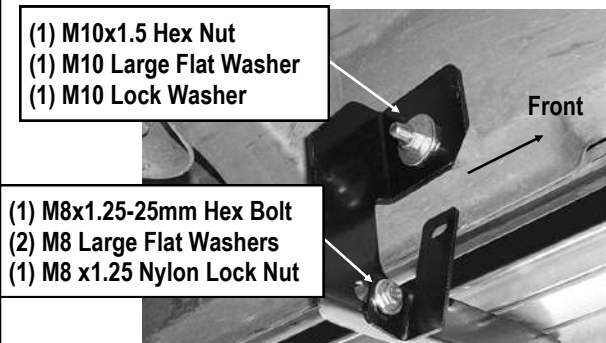

(Fig 7) Driver Side Center Brackets Installation

- (1) M10x1.5 Hex Nut
- (1) M10 Large Flat Washer
- (1) M10 Lock Washer

- (1) M8x1.25-25mm Hex Bolt
- (2) M8 Large Flat Washers
- (1) M8 x1.25 Nylon Lock Nut

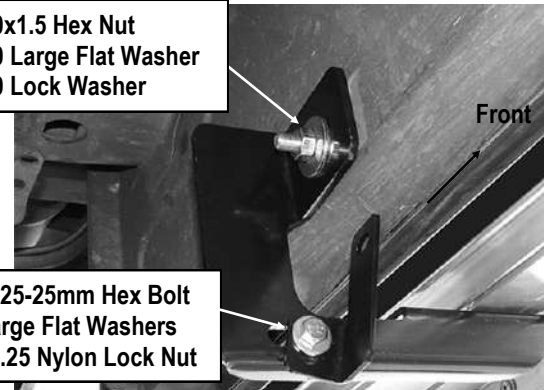

(Fig 8) Driver Side Rear Brackets Installation

STEP 5

Once all (3) mounting brackets are installed, then proceed to the Step Bar installation. According to the style of Step Bar proceed to the correct installation STEPS.

Note: Aluminum Step Bar refer to STEP 6; Stainless Steel Step Bar skip to STEP 7.

STEP 6

Aluminum Step Bar Installation:

Select a **Aluminum Step Bar**. Slip (3) M6x1-20mm Square Head Bolts into each bottom channel (Fig 9). Carefully position the Step Bar onto the (3) Mounting Brackets.

IMPORTANT: Do not slide the Step Bar on the Brackets or the bottom surface of the board will be damaged. Attach the Step Bar to each Mounting Brackets with (2) M6x1-20mm Square Head Bolts, (2) M6 Large Flat Washers and (2) M6X1 Nylon Lock Nuts, (Fig 10). Do not fully tighten at this time. Move to **Step 8-9**.

Level and adjust the Step Bar and fully tighten all hardware. Repeat **Steps 1-6 and 8-9** for the other side Step Bar installation. **The installation is completed!!!**

iBoard®



(Fig 9) Slip M6X1-20mm Square Head Bolts Into The Bottom Channels



(Fig 11) Slide & line up the U-Slider with the installed mounting brackets along bottom channel

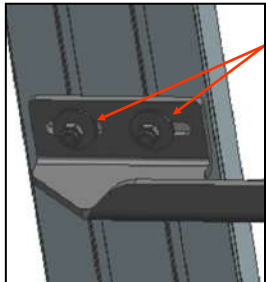

(2) M6X1-20mm Square Head Bolts
(2) M6 Large Flat Washers
(2) M6X1 Nylon Lock Nuts
IMPORTANT: TORQUE FOR 6MM FASTNERS MUST LESS THAN 6-7 FT-LBS OR THE FASTNERS WILL BE DAMAGED!

(Fig 10) Step Bar Installed Onto Mounting Bracket

STEP 7

Stainless Steel Step Bar Installation:

Select a **Stainless Steel Step Bar** (with the U-Sliders installed on the Bar). Loose the U-Sliders, reposition the U-Sliders onto the board according to the (3) Installed Mounting Brackets location, (Fig 11). Re-secure the U-Sliders on the Step Bar. Attach the Step Bar to the installed Mounting Brackets with (6) M6X1-20mm Hex Bolts, (6) M6 Large Flat Washers & (6) M6 Lock Washers, (Fig 12). Do not fully tighten hardware at this time. Move to **Step 8-9**.

Level and adjust the Step Bar and fully tighten all hardware. Repeat **Steps 1-6 and 7-9** for the other side Step Bar installation. **The installation is completed!!!**

(2) M6X1-20mm Hex Bolts
(2) M6 Large Flat Washers
(2) M6 Lock Washers
IMPORTANT: TORQUE FOR 6MM FASTNERS MUST LESS THAN 6-7 FT-LBS OR THE FASTNERS WILL BE DAMAGED!

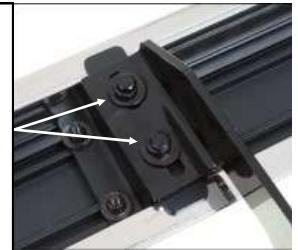

(Fig 12) Step Bar Installed on Bracket Installed (Example)

STEP 8

Move back to the (3) Driver Support Brackets up against the underside of the body and flat against the back of the pinch weld. Mark the location of the center of the slot onto the pinch weld, (Fig 13). Adjust Mounting Brackets up or down to level the Running Board and line up the Support Brackets above the bottom edge of the pinch weld. Repeat as necessary to line up and mark all (3) Driver Support Bracket locations.

IMPORTANT: Make sure do not mark too close to the edge of the pinch weld.

iBoard®

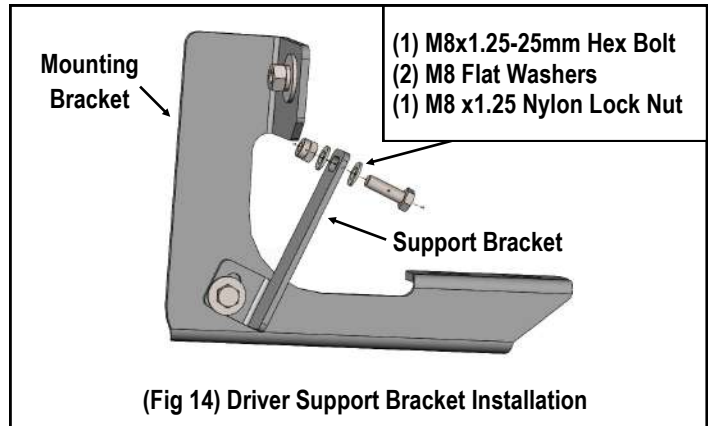
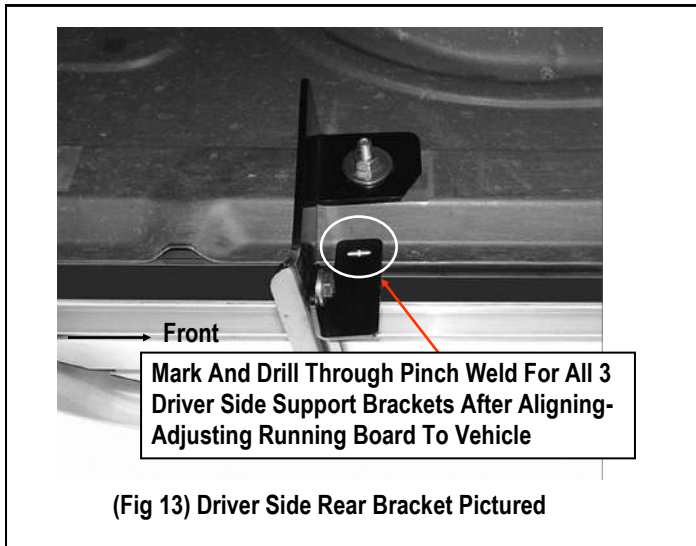

STEP 9

Drill (3) 5/16" (or 8mm) through holes on the pinch weld for all (3) Driver Support Brackets **IMPORTANT: Make sure do not drill too close to the edge of the pinch weld.**

Bolt each Support Bracket to the back of the pinch weld with (1) M8x1.25-25mm Hex Bolt, (2) M8 Flat Washers and (1) M8 x1.25 Nylon Lock Nut, (Fig 14). Do not fully tighten hardware at this time.

Attention

Do periodic inspections to the installation to make sure that all hardware is secure and tight.

In order to protect your bars/boards, please use only mild soap/non-abrasive products for cleaning.