

iBoard®

iBoard® by APS

PART#: IB-212

READ INSTRUCTIONS CAREFULLY BEFORE STARTING INSTALLATION. REMOVE CONTENTS FROM BOX AND VERIFY ALL PARTS ARE PRESENT. ASSISTANCE IS RECOMMENDED.

*ROCKER PANEL MOUNT
*NO DRILLING REQUIRED

Fastener Size	Tightening Torque (ft-lbs)	Required
6mm	6-7	√
8mm	16-18	√
10mm	31-32	X
12mm	56-58	X
14mm	92-94	X



Driver Side Step Bar

Front
↑

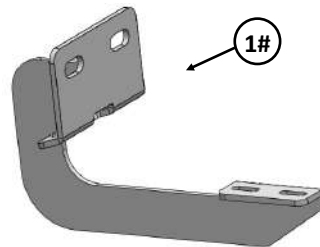
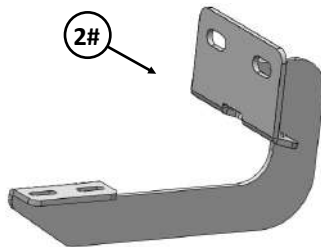
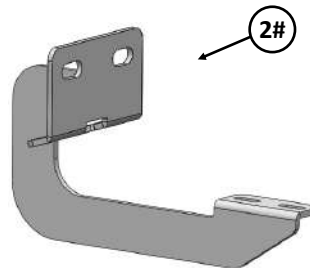
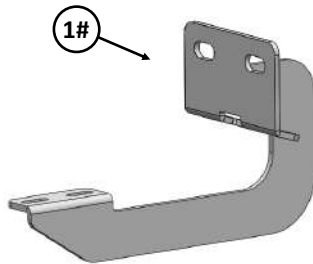







Passenger Side Step Bar



iBoard®

Mounting Bracket List					
Item	QTY	Description	Item	QTY	Description
1#	2	Driver Front / Passenger Rear Mounting Brackets	2#	2	Passenger Front / Driver Rear Mounting Brackets



Hardware Package A (For Bracket Installation)					
Item	QTY	Description	Item	QTY	Description
1#	8	M8X1.25-30mm Hex Bolts	5#	16	M8 Lock Washers
2#	8	M8X1.25-25mm Hex Bolts	6#	8	M8X1.25 Hex Nuts
3#	8	M8 Large Flat Washers	7#	8	M8 Clip Nuts
4#	16	M8 Flat Washers			

Hardware Package B (For Aluminum Step Bar Installation Only, Not Supply to SS. Step Bar)					
Item	QTY	Description	Item	QTY	Description
1#	8	M6X1-20mm Square Head Bolts	3#	8	M6X1 Nylon Lock Nuts
2#	8	M6 Large Flat Washers			

Hardware Package C (For Stainless Steel Step Bar Installation Only, Not Supply to Aluminum Step Bar)					
Item	QTY	Description	Item	QTY	Description
1#	8	M6X1-20mm Hex Bolts	3#	8	M6 Flat Washers
2#	8	M6 Lock Washers			

iBoard®

STEP 1

Starting on the driver side of the vehicle, locate the (2) holes in the bottom of the body panel, (pinch weld), toward the front tire, **(Fig 1)**. Next locate the rectangular opening and (2) small holes in the inner body panel directly above the holes in the pinch weld, **(Figs 1 & 2)**. **NOTE:** The holes on the inner panel may be covered with sealing tape or insulation, remove if equipped.

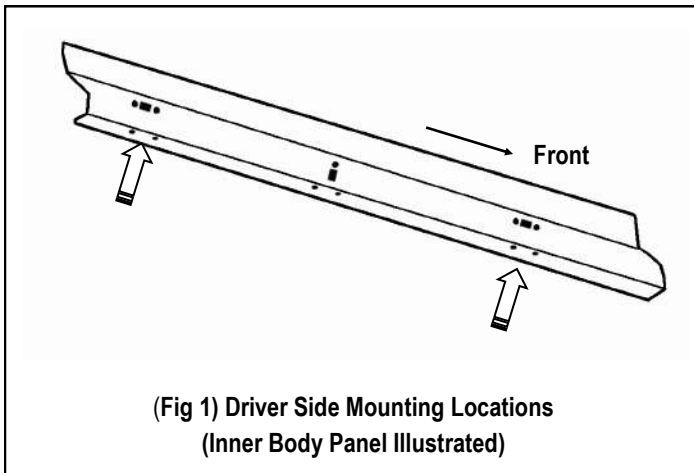

STEP 2

Slide (1) M8 Clip Nut into the rectangular opening with the nut towards the inside. Line up the threaded nut on the clip with the round hole, **(Fig 2)**. Repeat to install the 2nd M8 Clip Nut in remaining hole location.

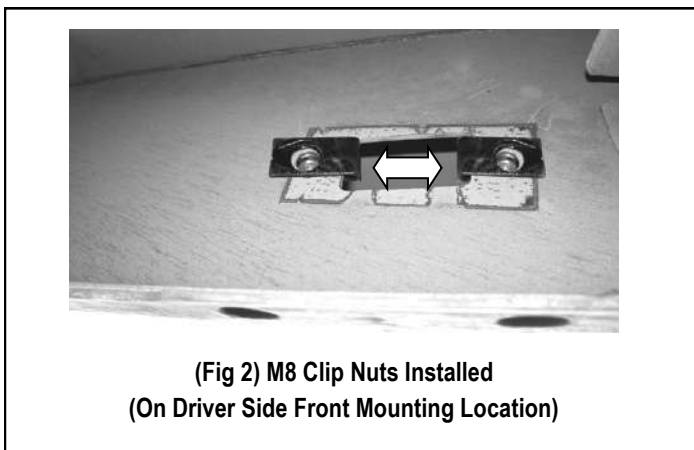

STEP 3

Select (1) Driver Front Mounting Bracket, attach the Mounting Bracket to the (2) M8 Clip Nuts with the included (2) M8x1.25-30mm Hex Bolts, (2) M8 Lock Washers and (2) M8 Large Flat Washers, **(Figs 3 & 4)**. Do not fully tighten hardware at this time. The cradle on the Mounting Bracket should face to the front of the vehicle.

NOTE: Depending on model and year, the brake cable may be run on the inside or outside of the Bracket.

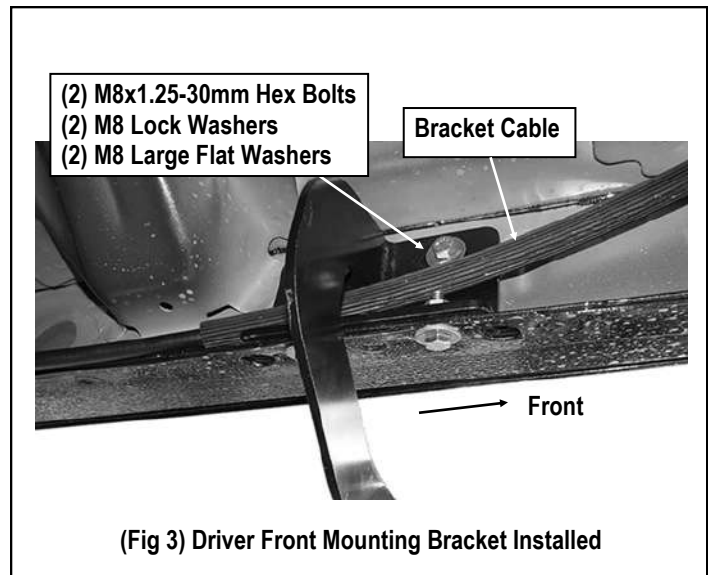

STEP 4

Align the bottom holes on the Driver Front Mounting Bracket with the (2) holes in the pinch weld. Bolt the Bracket to the pinch weld using the included (2) M8x1.25-25mm Hex Bolts, (4) M8 Flat Washers, (2) M8 Lock Washers and (2) M8 Hex Nuts, **(Fig 4)**. Do not fully tighten hardware at this time.

NOTE: Insert the bolts up from the bottom of the pinch weld and through the Bracket.

iBoard®

- (2) M8x1.25-25mm Hex Bolts
- (4) M8 Flat Washers
- (2) M8 Lock Washers
- (2) M8 Hex Nuts

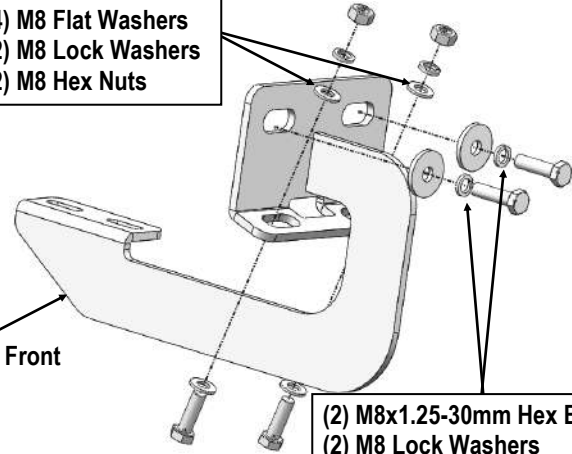

- (2) M8x1.25-30mm Hex Bolts
- (2) M8 Lock Washers
- (2) M8 Large Flat Washers

(Fig 4) Driver Front Mounting Bracket Installation

STEP 5

Move to the Driver Side Rear Mounting Location. Locate the last (2) mounting holes on the pinch weld, (Fig 1). Repeat Steps 2-4 for Driver Rear Mounting Bracket installation. Do not fully tighten hardware at this time.

NOTE: The cradle on the rear Bracket should face to the rear of the vehicle.

STEP 6

Once all (2) drivers side mounting brackets are installed, then proceed to the Step Bar installation. According to the style of Step Bar proceed to the correct installation STEPS.

Note: Aluminum Step Bar refer to STEP 7; Stainless Steel Step Bar skip to STEP 8.

STEP 7

Aluminum Step Bar Installation:

Select a **Aluminum Step Bar**. Slip (2) M6X1-20mm Square Head Bolts into each bottom channel (Fig 5). Carefully position the Step Bar onto the (2) Mounting Brackets.

IMPORTANT: Do not slide the Step Bar on the Brackets or the bottom surface of the board will be damaged. Attach the Step Bar to each Mounting Brackets with (2) M6X1-20mm Square Head Bolts, (2) M6 Large Flat Washers and (2) M6x1 Nylon Lock Nuts, (Fig 6). Do not fully tighten at this time.

Level and adjust the Step Bar and fully tighten all hardware. Repeat Steps 1-7 for the other side Step Bar installation. **The installation is completed!!!**



(Fig 5) Slip M6X1-20mm Square Head Bolts Into The Bottom Channels

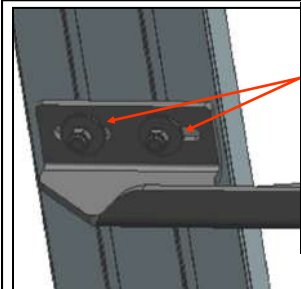

- (2) M6X1-20mm Square Head Bolts
 - (2) M6 Large Flat Washers
 - (2) M6X1 Nylon Lock Nuts
- IMPORTANT: TORQUE FOR 6MM FASTENERS MUST LESS THAN 6 -7 FT-LBS OR THE FASTNERS WILL BE DAMAGED!**

(Fig 6) Running Board Installed Onto Mounting Bracket

STEP 8

Stainless Steel Step Bar Installation:

Select a **Stainless Steel Step Bar** (with the U-Sliders installed on the Bar). Loose the U-Sliders, reposition the U-Sliders onto the board according to the (2) Installed Mounting Brackets location, (Fig 7). Re-secure the U-Sliders on the Step Bar. Attach the Step Bar to the installed Mounting Brackets with (4) M6X1-20mm Hex Bolts, (4) M6 Large Flat Washers & (4) M6 Lock Washers, (Fig 8). Do not fully tighten hardware at this time.

Level and adjust the Step Bar and fully tighten all hardware. Repeat Steps 1-6 and 8 for the other side Step Bar installation. **The installation is completed!!!**

iBoard®



(Fig 7) Slide & line up the U-Slider with the installed mounting brackets along bottom channel

(2) M6X1-20mm Hex Bolts
(2) M6 Large Flat Washers
(2) M6 Lock Washers
**IMPORTANT: TORQUE FOR 6MM
FASTNERS MUST LESS THAN 6-
7 FT-LBS OR THE FASTNERS
WILL BE DAMAGED!**

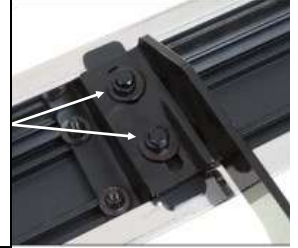

(Fig 8) Step Bar Installed on Bracket Installed (Example)

Attention

Do periodic inspections to the installation to make sure that all hardware is secure and tight.
In order to protect your bars/boards, please use mild soap/non-abrasive products for cleaning only.