

# iBoard®



Scan for  
Installation Video

## iBoard® by APS

PART#: IB-003/011/003S

READ INSTRUCTIONS CAREFULLY BEFORE STARTING INSTALLATION. REMOVE CONTENTS FROM BOX AND VERIFY ALL PARTS ARE PRESENT. ASSISTANCE IS RECOMMENDED.

\*ROCKER PANEL MOUNT  
\*NO DRILLING REQUIRED

| Fastener Size | Tightening Torque (ft-lbs) | Required |
|---------------|----------------------------|----------|
| 6mm           | 6-7                        | √        |
| 8mm           | 16-18                      | X        |
| 10mm          | 31-32                      | √        |
| 12mm          | 56-58                      | X        |
| 14mm          | 92-94                      | X        |

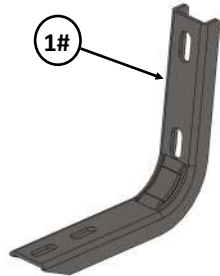

1#

Front  
↑

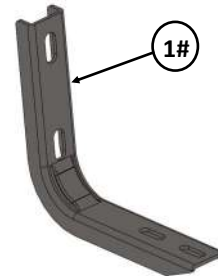

1#

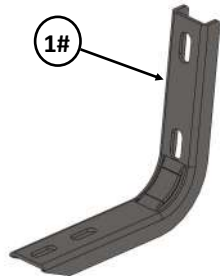

1#

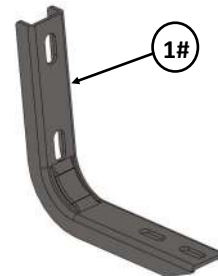

1#

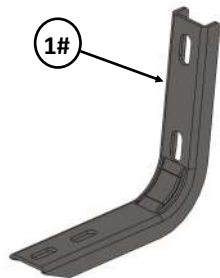

1#

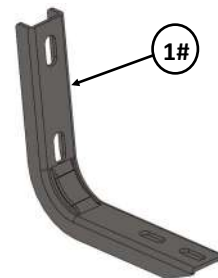

1#



Driver Side Step Bar

Note: (6) Mounting Brackets Are Universal.

Passenger Side Step Bar

Customer Support: [info@iboardauto.com](mailto:info@iboardauto.com)





| Mounting Bracket List |     |                   |      |     |             |
|-----------------------|-----|-------------------|------|-----|-------------|
| Item                  | QTY | Description       | Item | QTY | Description |
| 1#                    | 6   | Mounting Brackets |      |     |             |

| Hardware Package A (For Bracket Installation) |     |                        |      |     |                  |
|---|-----|------------------------|------|-----|------------------|
| Item  | QTY | Description            | Item | QTY | Description      |
| 1#  | 12  | M10X1.5-30mm Hex Bolts | 4#   | 6   | M10X1.5 Hex Nuts |
| 2#  | 18  | M10 Flat Washers       | 5#   | 6   | M10 Clip Nuts    |
| 3#  | 12  | M10 Lock Washers       |      |     |                  |

 1#

 2#

 3#

 4#

 5#

| Hardware Package B (For Aluminum Step Bar Installation Only, Not Supply to SS. Step Bar) |     |                             |      |     |                      |
|--|-----|-----------------------------|------|-----|----------------------|
| Item   | QTY | Description                 | Item | QTY | Description          |
| 1#   | 12  | M6X1-20mm Square Head Bolts | 3#   | 12  | M6X1 Nylon Lock Nuts |
| 2#   | 12  | M6 Large Flat Washers       |      |     |                      |

 1#

 2#

 3#

| Hardware Package C (For Stainless Steel Step Bar Installation Only, Not Supply to Aluminum Step Bar) |     |                     |      |     |                 |
|--|-----|---------------------|------|-----|-----------------|
| Item   | QTY | Description         | Item | QTY | Description     |
| 1#   | 12  | M6X1-20mm Hex Bolts | 3#   | 12  | M6 Flat Washers |
| 2#   | 12  | M6 Lock Washers     |      |     |                 |

 1#

 2#

 3#



## STEP 1

Starting on the driver side front of the vehicle. Locate the (3) mounting locations along the rocker panel & pinch weld. Each mounting location on the rocker panel is comprised of a rectangular hole with a round hole and (1) hole on pinch weld, ( Figs 1-2 ).

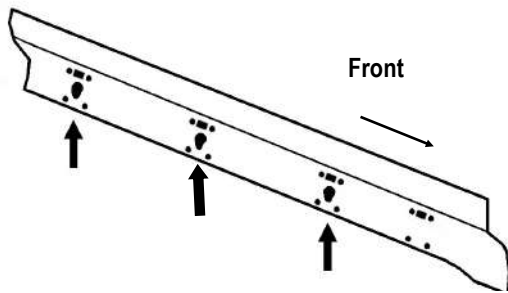

(Fig 1) Driver Side Mounting Locations  
(Illustrated Back View of Rocker Panel)

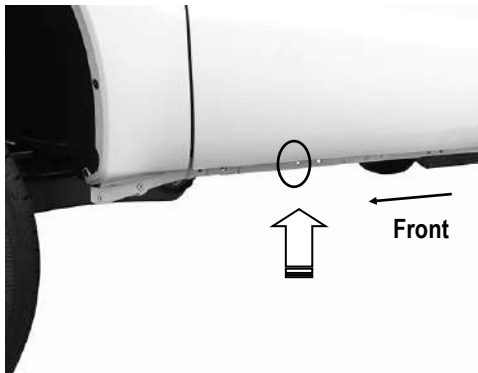

(Fig 2) The Mounting Holes on the Pinch Weld

## STEP 2

Select (1) M10 Clip Nut. Insert the Clip Nut into the rectangular opening. Line up the threaded hole of Clip Nut with the round hole beside the rectangular opening, ( Fig 3 ).

**NOTE:** Make sure the threaded nut on Clip Nut must toward the inner side of the rocker panel, ( Fig 3 ).

Line Up Clip Nuts With  
Factory Round Hole

Factory Hole In Pinch  
Weld Pictured From  
Behind Body Panel

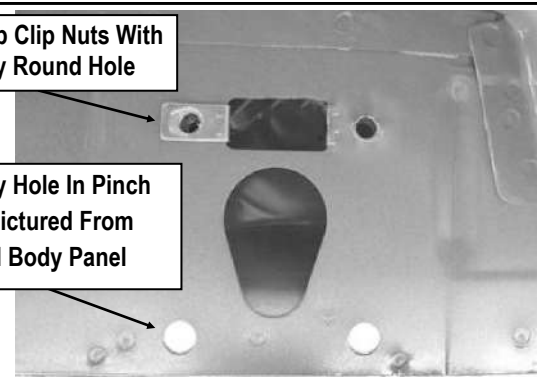

(Fig 3) M10 Clip Nut Installed

## STEP 3

Partially attach the Driver Front Mounting Bracket to the M10 Clip Nut with the included (1) M10X1.5-30mm Hex Bolt, (1) M10 Lock Washer and (1) M10 Flat Washer, ( Fig 4 ). Bolt the (1) lower hole on the Mounting Bracket to the (1) hole in the pinch weld with the included (1) M10X1.5-30mm Hex Bolt, (2) M10 Flat Washers, (1) M10 Lock Washer and (1) M10X1.5 Hex Nut, ( Fig 4 ). Do not fully tighten hardware at this time.

(1) M10X1.5-30mm Hex Bolt  
(1) M10 Flat Washer  
(1) M10 Lock Washer

(1) M10X1.5-30mm Hex Bolt  
(2) M10 Flat Washers  
(1) M10 Lock Washer  
(1) M10X1.5 Hex Nut

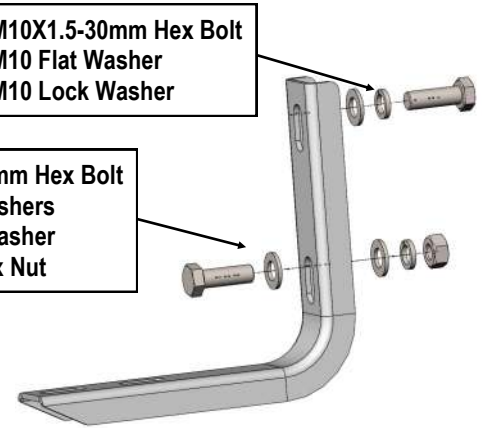

(Fig 4) Driver Front Mounting Bracket Installation Pictured

## STEP 4

Move along the vehicle to the driver side center & rear mounting location. Repeat **Steps 1-3** to install the Driver Center & Rear Mounting Bracket.

**Note: (6) Mounting Brackets Are Universal.**



## STEP 5

Once all (3) mounting brackets are installed, then proceed to the Step Bar installation. According to the style of Step Bar proceed to the correct installation STEPS.

**Note:** Aluminum Step Bar refer to 6; Stainless Steel Step Bar skip to STEP 7.

## STEP 6

### Aluminum Step Bar Installation:

Select a **Aluminum Step Bar**. Slip (3) M6x1-20mm Square Head Bolts into each bottom channel (**Fig 5**). Carefully position the Step Bar onto the (3) Mounting Brackets.

**IMPORTANT:** Do not slide the Step Bar on the Brackets or the bottom surface of the board will be damaged. Attach the Step Bar to each Mounting Brackets with (2) M6x1-20mm Square Head Bolts, (2) M6 Large Flat Washers and (2) M6X1 Nylon Lock Nuts, (**Fig 6**). Do not fully tighten at this time.

Level and adjust the Step Bar and fully tighten all hardware. Repeat **Steps 1-6** for the other side Step Bar installation. **The installation is completed!!!**



(Fig 5) Slip M6X1-20mm Square Head Bolts Into The Bottom Channels

(2) M6X1-20mm Square Head Bolts  
(2) M6 Large Flat Washers  
(2) M6X1 Nylon Lock Nuts  
**IMPORTANT: TORQUE FOR 6MM FASTNERS MUST LESS THAN 6-7 FT-LBS OR THE FASTNERS WILL BE DAMAGED!**

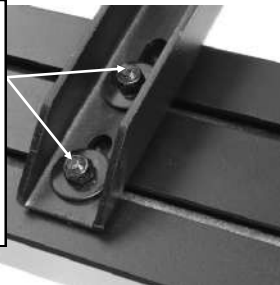

(Fig 6) Step Bar Installed Onto Mounting Bracket

## STEP 7

### Stainless Steel Step Bar Installation:

Select a **Stainless Steel Step Bar** (with the U-Sliders installed on the Bar). Loose the U-Sliders, reposition the U-Sliders onto the board according to the (3) Installed Mounting Brackets location, (**Fig 7**). Re-secure the U-Sliders on the Step Bar. Attach the Step Bar to the installed Mounting Brackets with (6) M6X1-20mm Hex Bolts, (6) M6 Large Flat Washers & (6) M6 Lock Washers, (**Fig 8**). Do not fully tighten hardware at this time. Level and adjust the Step Bar and fully tighten all hardware. Repeat **Steps 1-5 and 7** for the other side Step Bar installation. **The installation is completed!!!**



(Fig 7) Slide & line up the U-Slider with the installed mounting brackets along bottom channel

(2) M6X1-20mm Hex Bolts  
(2) M6 Large Flat Washers  
(2) M6 Lock Washers

**IMPORTANT: TORQUE FOR 6MM FASTNERS MUST LESS THAN 6-7 FT-LBS OR THE FASTNERS WILL BE DAMAGED!**

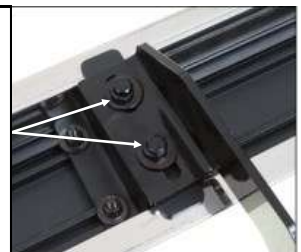

(Fig 8) Step Bar Installed on Bracket Installed (Example)

### Attention

Do periodic inspections to the installation to make sure that all hardware is secure and tight.

In order to protect your bars/boards, please use mild soap/non-abrasive products for cleaning only.