

# iBoard®

## iBoard® by APS

PART#: IB-008

READ INSTRUCTIONS CAREFULLY BEFORE STARTING INSTALLATION. REMOVE CONTENTS FROM BOX AND VERIFY ALL PARTS ARE PRESENT. ASSISTANCE IS RECOMMENDED.

\*ROCKER PANEL MOUNT  
\*NO DRILLING REQUIRED

Fastener Size	Tightening Torque (ft-lbs)	Required
6mm	6-7	√
8mm	16-18	X
10mm	31-32	√
12mm	56-58	X
14mm	92-94	X



Driver Side Step Bar

Front  
↑

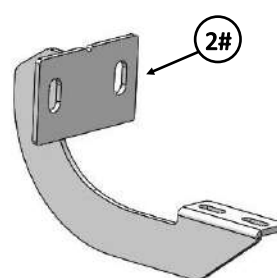
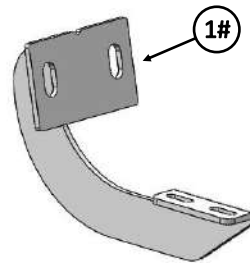
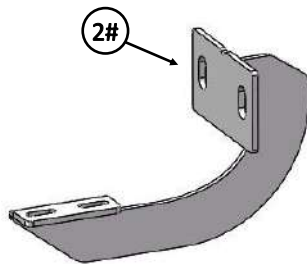
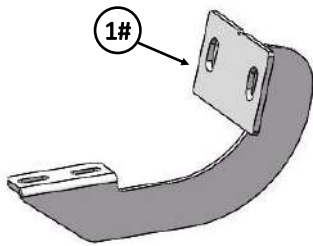

Passenger Side Step Bar

# iBoard®

Mounting Bracket List					
Item	QTY	Description	Item	QTY	Description
1#	2	Driver / Passenger Front Mounting Brackets	2#	2	Driver / Passenger Rear Mounting Brackets

Hardware Package A (For Bracket Installation)					
Item	QTY	Description	Item	QTY	Description
1#	4	M10 Large Double Bolt Plates	4#	8	M10 Large Flat Washers
2#	1	M10 Small Double Bolt Plates	5#	8	M10 Lock Washers
3#	2	Plastic Washers	6#	8	M10 Hex Nuts

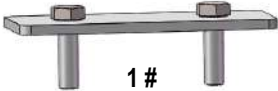
 1 #

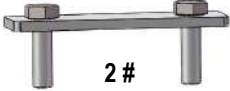
 2 #

 3 #

 4 #

 5 #

 6 #

Hardware Package B (For Aluminum Step Bar Installation Only, Not Supply to SS. Step Bar)					
Item	QTY	Description	Item	QTY	Description
1#	8	M6X1-20mm Square Head Bolts	3#	8	M6 Nylon Lock Nuts
2#	8	M6 Large Flat Washers			

 1 #

 2 #

 3 #

Hardware Package C (For Stainless Steel Step Bar Installation Only, Not Supply to Aluminum Step Bar)					
Item	QTY	Description	Item	QTY	Description
1#	8	M6X1-20mm Hex Bolts	3#	8	M6 Flat Washers
2#	8	M6 Lock Washers			

 1 #

 2 #

 3 #

# iBoard®

## STEP 1

Starting on the driver side front mounting location of the vehicle. Remove the large oval rubber cover located on the inner side of the body panel, (Fig 1). Insert (1) M10 Large Double Bolt Plate into the oval hole, (Fig 2) and pull it back into position against the inner body panel, (Fig 3).

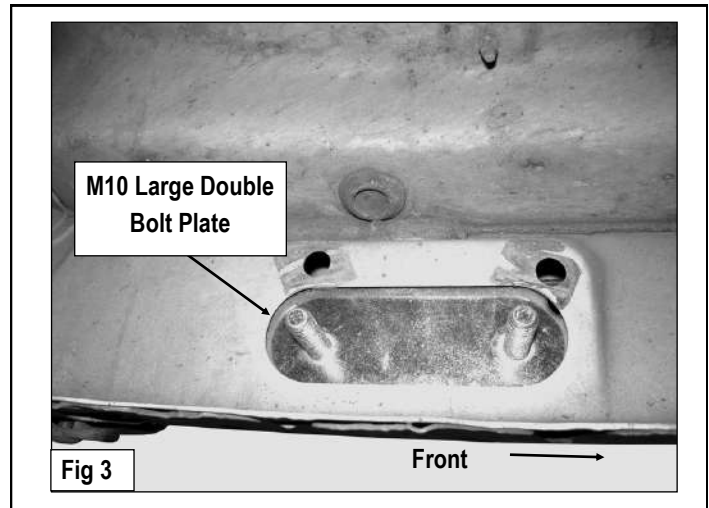
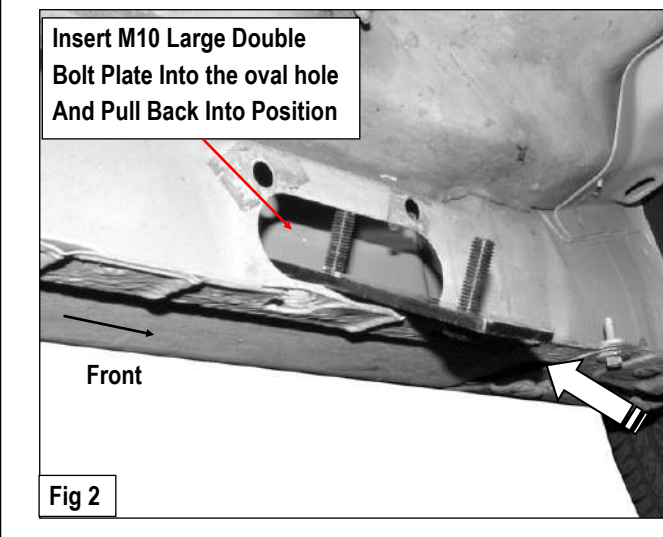
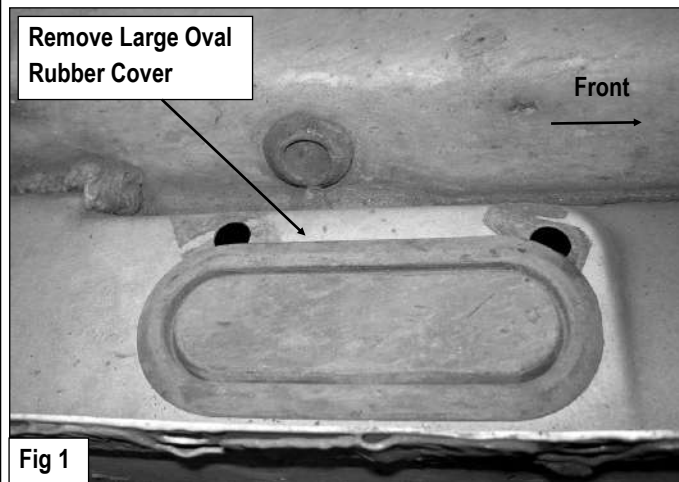

## STEP 2

Select (1) Driver Front Mounting Bracket. Secure the Driver Front Mounting Bracket to the M10 Large Double Bolt Plate with the included (2) M10 Lock Washers, (2) M10 Large Flat Washers and (2) M10 Hex Nuts, (Fig 4). Do not fully tighten hardware at this time.

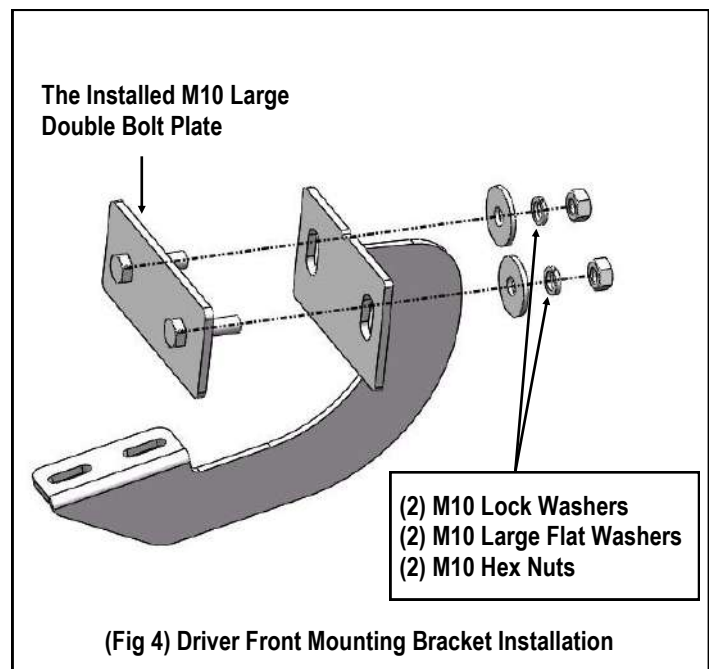

# iBoard®

## STEP 3

Move to Driver Side Rear Mounting Location. Repeat **Steps 1-2** for Driver Rear Mounting Bracket installation. Do not fully tighten hardware at this time.

**NOTE: On 3-door models**, insert the M10 Small Double Bolt Plate into the large, round hole and line up with the smaller round hole, (**Fig 5**). Then use the included Plastic Washers to hold the Bolt Plate in position and secure the Bracket as previously described in **Step 1-2**.

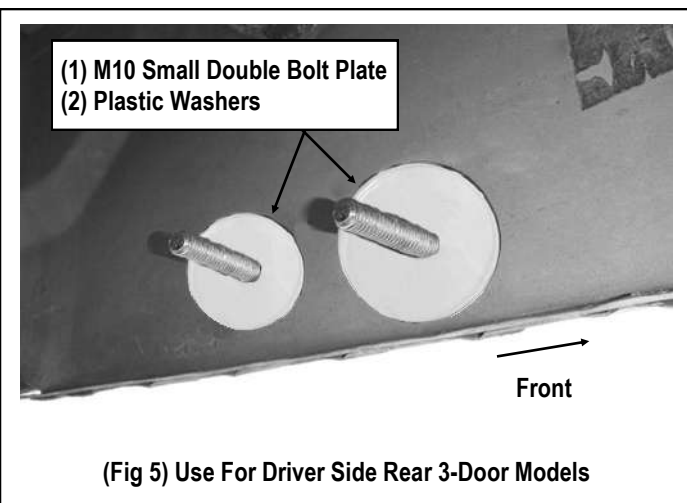

## STEP 4

Once all (2) mounting brackets are installed, then proceed to the Step Bar installation. According to the style of Step Bar proceed to the correct installation STEPS.

**Note: Aluminum Step Bar refer to STEP 5; Stainless Steel Step Bar skip to STEP 6.**

## STEP 5

### **Aluminum Step Bar Installation:**

Select a **Aluminum Step Bar**. Slip (2) M6x1-20mm Square Head Bolts into each bottom channel (**Fig 5**). Carefully position the Step Bar onto the (2) Mounting Brackets.

**IMPORTANT:** Do not slide the Step Bar on the Brackets or the bottom surface of the board will be damaged. Attach the Step Bar to each Mounting Brackets with (2) M6x1-20mm Square Head Bolts, (2) M6 Large Flat Washers and (2) M6 Nylon Lock

Nuts, (**Fig 6**). Do not fully tighten at this time. Level and adjust the Step Bar and fully tighten all hardware. Repeat **Steps 1-5** for the other side Step Bar installation. **The installation is completed!!!**



(Fig 6) Slip M6X1-20mm Square Head Bolts Into The Bottom Channels

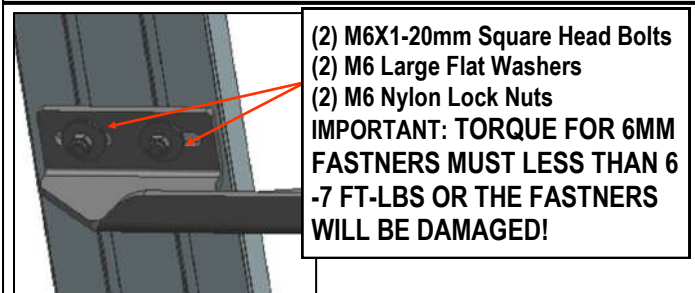

(Fig 7) Running Board Installed Onto Mounting Bracket

## STEP 6

### **Stainless Steel Step Bar Installation:**

Select a **Stainless Steel Step Bar** (with the U-Sliders installed on the Bar). Loose the U-Sliders, reposition the U-Sliders onto the board according to the (2) Installed Mounting Brackets location, (**Fig 7**). Re-secure the U-Sliders on the Step Bar. Attach the Step Bar to the installed Mounting Brackets with (4) M6X1-20mm Hex Bolts, (4) M6 Large Flat Washers & (4) M6 Lock Washers, (**Fig 8**). Do not fully tighten hardware at this time. Level and adjust the Step Bar and fully tighten all hardware. Repeat **Steps 1-4 and 6** for the other side Step Bar installation. **The installation is completed!!!**

# iBoard®



(Fig 8) Slide & line up the U-Slider with the installed mounting brackets along bottom channel

(2) M6X1-20mm Hex Bolts  
(2) M6 Large Flat Washers  
(2) M6 Lock Washers  
**IMPORTANT: TORQUE FOR 6MM  
FASTNERS MUST LESS THAN 6-  
7 FT-LBS OR THE FASTNERS  
WILL BE DAMAGED!**

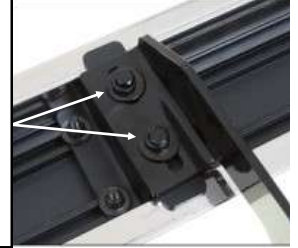

(Fig 9) Step Bar Installed on Bracket Installed (Example)

### Attention

Do periodic inspections to the installation to make sure that all hardware is secure and tight.  
In order to protect your bars/boards, please use only mild soap/non-abrasive products for cleaning.