

PARTS LIST:

1	Driver/left side Running Board	12	8mm x 30mm Hex Bolts
1	Passenger/right side Running Board	12	8mm x 25mm Hex Bolts
6	Mounting Brackets	12	8mm x 28mm x 3mm Large Flat Washers
12	10mm x 35mm Hex Bolts	24	8mm x 24mm x 2mm STD Flat Washers
24	10mm x 27mm x 3mm Flat Washers	24	8mm Lock Washers
12	10mm Nylon Lock Nuts	12	8mm Hex Nuts
12	8mm Clip-On Nuts		

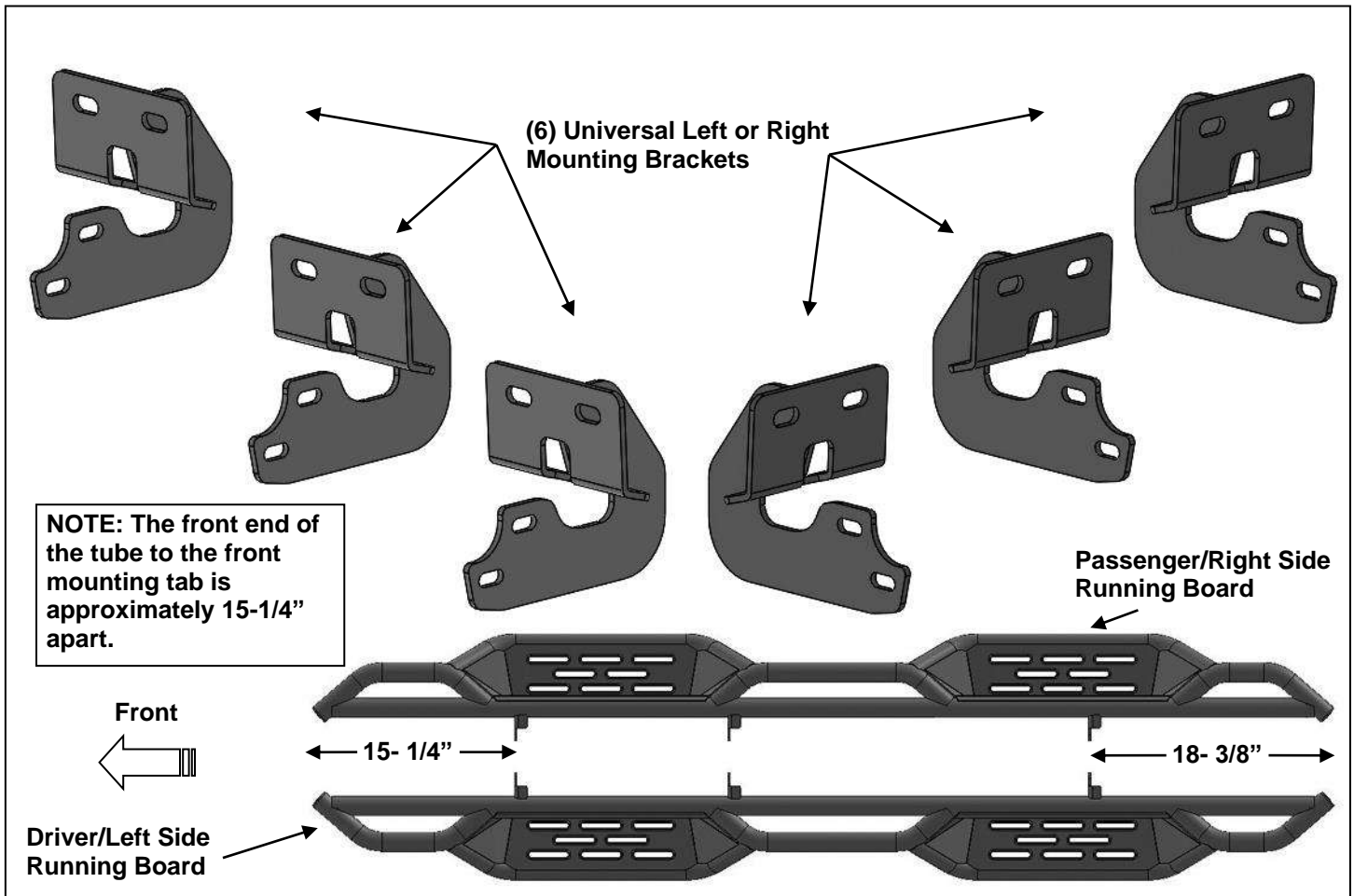

PROCEDURE:

- 1. REMOVE CONTENTS FROM BOX. VERIFY ALL PARTS ARE PRESENT. READ INSTRUCTIONS CAREFULLY BEFORE STARTING INSTALLATION.**
- Starting on the driver/left side of the vehicle, locate the (2) holes in the bottom of the body panel, (pinch weld), toward the front tire, **(Figure 1)**. Next locate the rectangular opening and (2) small holes in the inner body panel directly above the holes in the pinch weld, **(Figures 1 & 2)**. **NOTE:** The holes in the inner panel may be covered with sealing tape or insulation.
- Slide (1) 8mm Clip Nut into the rectangular opening with the nut towards the inside. Line up the threaded nut on the clip with the round hole, **(Figure 2)**. Repeat to install the 2nd 8mm Clip Nut in remaining hole location.
- Select (1) Universal Mounting Bracket. Attach the Bracket to the (2) Clip Nuts with the included (2) 8mm x 30mm Hex Bolts, (2) 8mm Lock Washers and (2) 8mm x 28mm Large Flat Washers, **(Figures 3 & 5)**. **NOTE:** Depending on model and year, the brake cable may be run on the inside or outside of the Bracket. Do not tighten hardware at this time.
- Align the bottom holes in the front Bracket with the (2) holes in the pinch weld. Attach the Bracket to the pinch weld using the included (2) 8mm x 25mm Hex Bolts, (4) 8mm x 24mm STD Flat Washers, (2)

8mm Lock Washers and (2) 8mm Hex Nuts, (**Figures 4 & 5**). **NOTE:** Insert the bolts up from the bottom of the pinch weld and through the Bracket.

6. Move along the cab to the center mounting location, (**Figure 1**). Repeat **Steps 2—5** for center Bracket installation, (**Figure 6**). Do not tighten hardware at this time.
7. Continue along the cab to the rear mounting location and locate the last (2) mounting holes in the pinch weld at the back of the cab, (**Figure 1**). Repeat **Steps 2—5** for rear Bracket installation, (**Figure 7**).
8. Select driver/left side Running Board. **NOTE:** The Passenger and Driver side Running Board look very similar but each one is unique. Use the illustration above to help identify each Running Board.
9. With assistance, carefully position the Running Board onto the rear facing side of the (3) Mounting Brackets. Attach the Running Board to the Brackets with (6) 10mm Hex Bolts, (12) 10mm Flat Washers and (6) 10mm Nylon Lock Nuts, (**Figures 8—10**). Do not tighten hardware at this time.
10. Level and adjust the Running Board and tighten all hardware.
11. Repeat **Steps 2—10** for passenger/right side Running Board installation.
12. Do periodic inspections to the installation to make sure that all hardware is secure and tight.

To protect your investment, wax this product after installing. Regular waxing is recommended to add a protective layer over the finish. Do not use any type of polish or wax that may contain abrasives that could damage the finish. Mild soap may be used to clean the Running Board.

Driver/Left Side Installation Pictured

Locate holes through pinch weld (arrows) to determine mounting locations

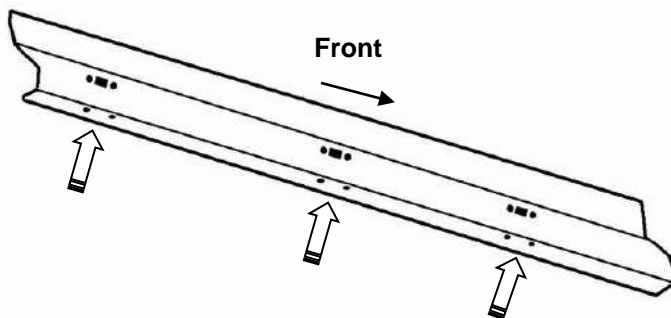

(Fig 1) Driver/left side inner body panel illustrated

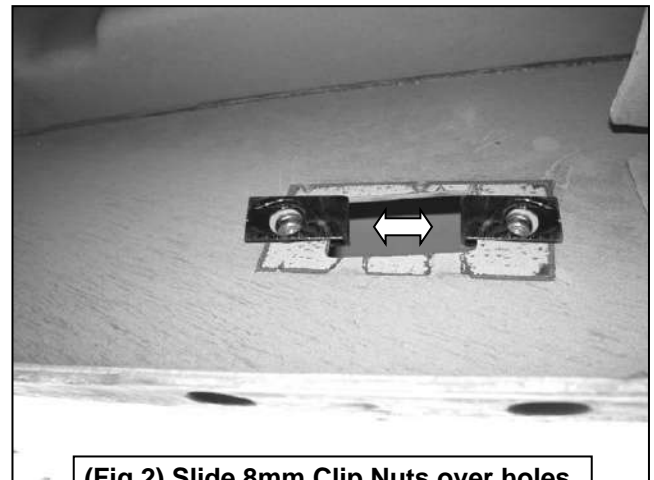

(Fig 2) Slide 8mm Clip Nuts over holes

Driver/Left Side Installation Pictured

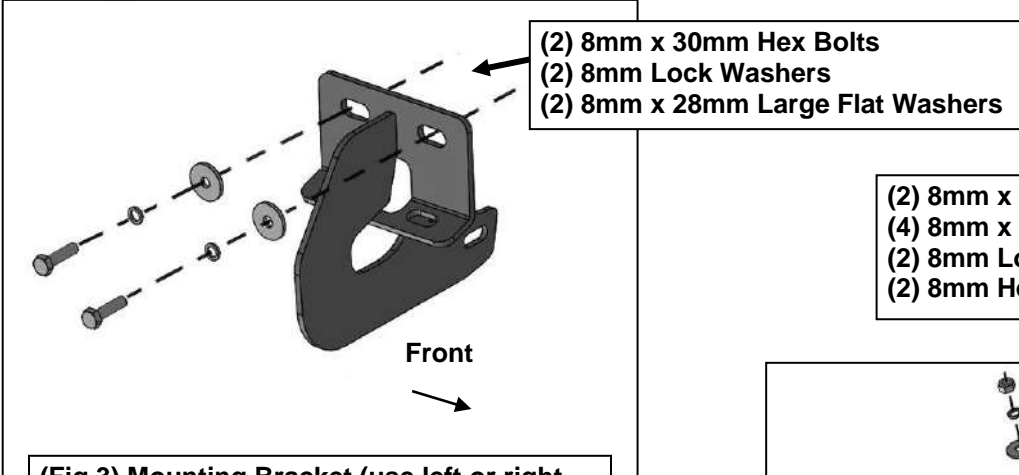

(Fig 3) Mounting Bracket (use left or right side) attached to inner body panel

- (2) 8mm x 25mm Hex Bolts
- (4) 8mm x 24mm STD Flat Washers
- (2) 8mm Lock Washers
- (2) 8mm Hex Nuts

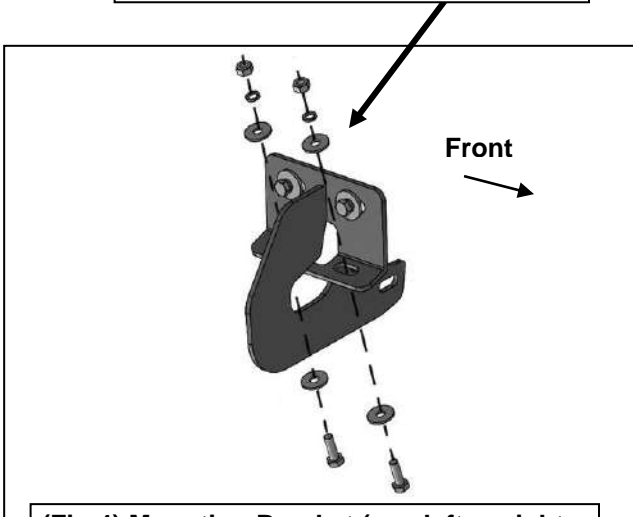

(Fig 4) Mounting Bracket (use left or right side) attached to pinch weld

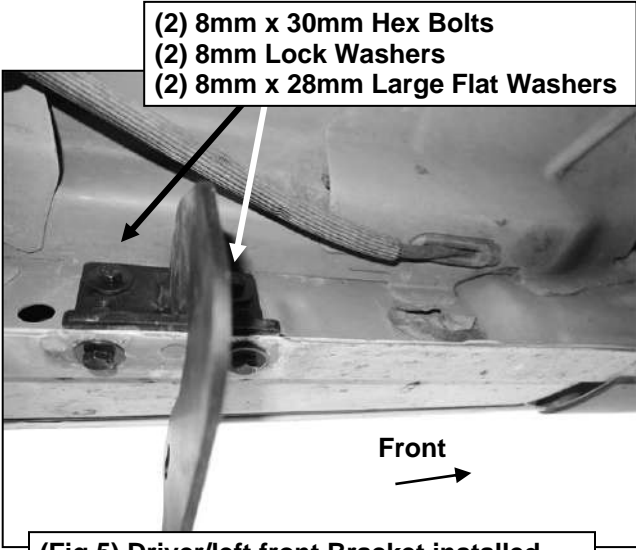

(Fig 5) Driver/left front Bracket installed



(Fig 6) Driver/left center Bracket installed

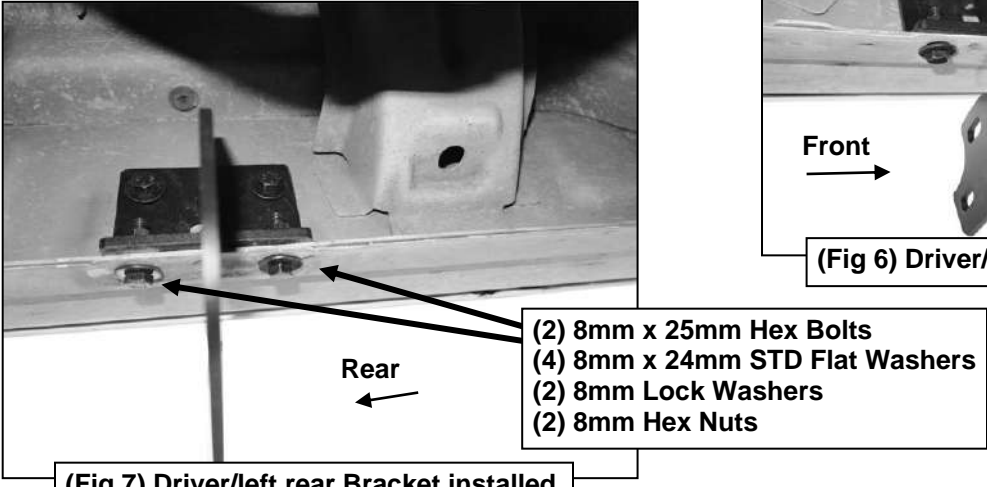

(Fig 7) Driver/left rear Bracket installed

Driver/Left Side Installation Pictured

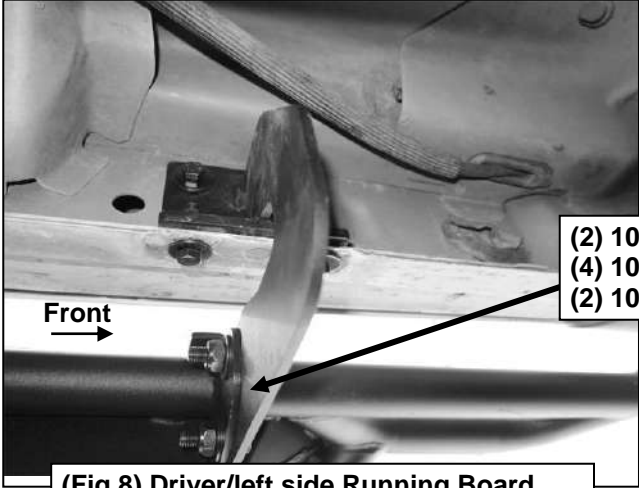

- (2) 10mm Hex Bolts
- (4) 10mm Flat Washers
- (2) 10mm Nylon Lock Nuts

(Fig 8) Driver/left side Running Board attached to front Bracket

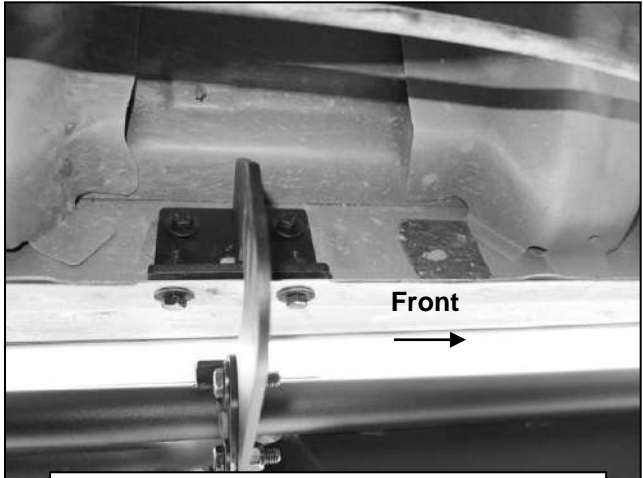

(Fig 9) Driver/left side Running Board attached to center Bracket

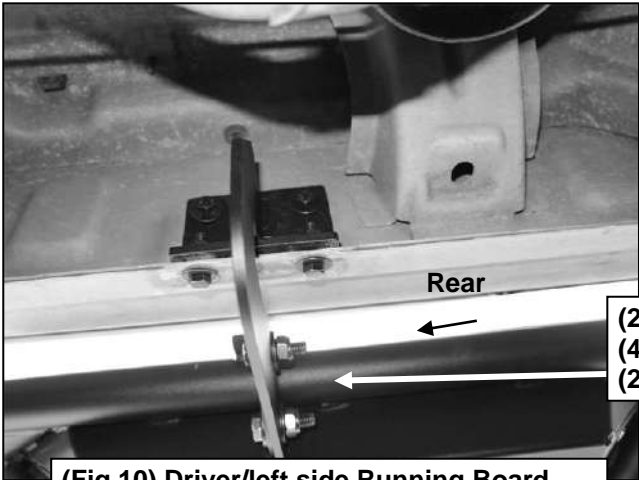

- (2) 10mm Hex Bolts
- (4) 10mm Flat Washers
- (2) 10mm Nylon Lock Nuts

(Fig 10) Driver/left side Running Board attached to rear Bracket



Complete Installation